

Operating & Maintenance Manual

Alert-2 Microprocessor Based Digital Alarm System v6.3

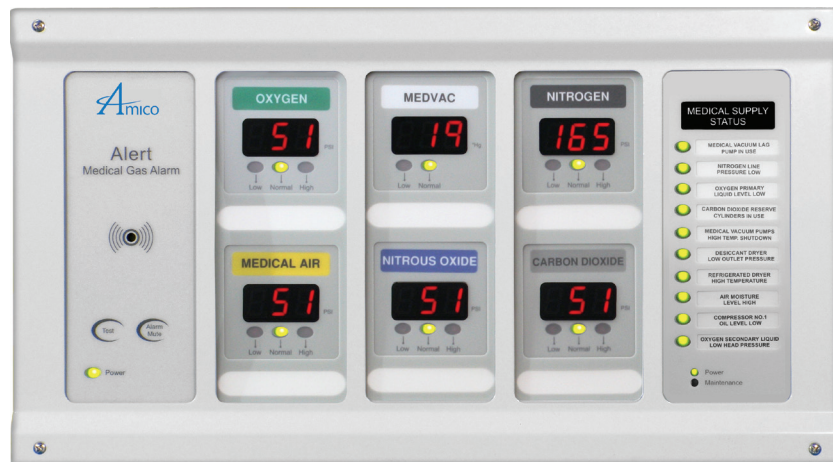

Amico

Contents

User Responsibility	1
Introduction	1-2
Features	2
Description of the Alarm	3
Shipment Details	3
The Alarm Back Box	3
The Frame/Module Assembly	3
Description of the Modules	3-4
Common to all Alert-2 Alarms	3
System Power Supply	3
Annunciator Module	3
Blank Module	3
Compact Display Module	4
Sensor Module	4
Master Alarm	4
Master/Nema 4 Status Module	4
Computer Interface Module	4
Installation	5-6
The Alarm Box	5
For Local Sensor Only	5
Standing Pressure Test	5
Frame/Module Assembly	5
Sensor	6
Local	6
Remote	6
Wiring	7-8
System Power Supply	7
Annunciator Module	7
Sensor Module	7
Local	7
Remote	7-8
Compact Display Module	8
Master/NEMA 4 Status Module	8
Computer Interface Module	8
Closing the Frame/Module Assembly	8

Contents

Annunciator Module	9
Noise Level Control	9
Control of Remote Alarm Buzzer	9
Steps to Re-Calibrate the Sensor from Compact Module	9
Compact Display Module - To Change High and Low Pressure Set Points	10-14
PSI/kPa/BAR Selections	11
Inch Hg/kPa/BAR Selections	12
Common Settings for Pressure and Vacuum	12
Setting Factory Default	13
Setting Gas Identification Switches	13
Chart of Gas Specific Settings of Dip-Switches	14
Master/NEMA 4 Status Module	14-16
Repeat Alarm	14
Signal Input Selection	15
Maintenance Mode	15-16
Troubleshooting Guide	17-18
Error Code Messages on the Display Module	19
Model Numbers	20-22
Master Alarm	20
NEMA 4 Alarm	20
Compact Alarm	21
Compact Master Combination Alarm	22
Spare Part Numbers	23-25
DISS Kits	25
Demand Check Valves	25
Retro-Fit Parts	25
Dimensions	26-29
Master Alarm	26
Compact Alarm	27
Compact Master Alarm Combination	28
NEMA 4 Alarm	29

Contents

Appendix A	30
Wiring Diagram: Auto-Switching Power Supply	
Appendix B	31
Wiring Diagram: Annunciator	
Appendix C	32
Wiring Diagram: Automatic Voice/Pager Dialing System	
Appendix D	33
Wiring Diagram: Compact Display Module - Local Sensor	
Appendix E	34
Wiring Diagram: Compact Display Module - Remote Sensor	
Appendix F	35
Wiring Diagram: Compact Module to Master	
Appendix G	36
Wiring Diagram: Abnormal Condition	
Appendix H	37
Wiring Diagram: Master/NEMA 4 Module	
Appendix I	38
Wiring Diagram: Pressure Switch Connection to a Master Alarm	
Appendix J	39
Wiring Diagram: Computer Interface Module	
Appendix K	40
Wiring Diagram: Master to Slave Module	
Appendix L	41
Technical Specifications	
Appendix M	42
Wiring	
Notes	43

User Responsibility

The information contained in this Installation and Operation Maintenance Manual, pertains only to the ALERT-2 microprocessor based digital alarm. This product will perform to conformity with the descriptions contained in this manual, when assembled, operated, maintained and serviced in accordance with the installation instructions provided.

The alarm must be checked periodically. Parts that are broken, missing, worn, distorted or contaminated, must be replaced immediately. Should such repair or replacement become necessary, please contact Amico Corporation or their distributors.

All alarms should not be repaired, or altered without prior written or verbal approval of Amico Corporation or its distributors. Failure to comply will void all warranty on the alarm.

Statements in this manual preceded by the words **WARNING, CAUTION, DANGER** and **NOTE** are of special significance. Please read these sections carefully.

NOTE: Amico strongly recommends that alarms be checked annually by qualified staff.



WARNING: denotes steps which can prevent injury.



CAUTION: denotes steps which can prevent damage to equipment.



DANGER: denotes steps which can prevent electrical shock to equipment or to prevent serious injury and/or death.

Introduction

The AMICO Medical Gas Alarm System (ALERT-2) incorporates the latest microprocessor technology for alarm and surveillance systems. The alarm has been designed to provide user flexibility and reliability. This manual will enable the customer to install, use and maintain the alarm properly.

All Gases or Vacuum are displayed with large Red LED's for clear visibility. To facilitate the monitoring function by hospital personnel, a trend bar is provided to show the direction of the gas/vacuum pressure. Under normal operation, the gas trend indicator will be in the GREEN - OK position. If the gas pressure approaches alarm condition, the trend indicator will display a YELLOW - Caution indicator. If an alarm condition occurs, a RED-Alarm indicator will be displayed and the buzzer will sound.

There are two buttons located on the front face of the Annunciator module. They are the "TEST" and "ALARM MUTE" buttons. The function of the "Test" button is to verify that the buzzer and all the alarm LED's are in normal working condition. The function of the "Alarm Mute" button is to silence an alarm that has occurred.

A master status module monitors source equipment such as: Oxygen, Nitrous Oxide, Air compressors, Vacuum pumps, Air dryers, high/low pressure switches, etc. This module can be connected to a "Building Management System", with a piggy-back computer interface board, that attaches to the master module.

The Alert-2 microprocessor based digital alarm system complies with NFPA 99 and UL Listed to U.S. and Canadian safety standards.

Features

- Individual Microprocessor on each display, sensor and master module.
- Gas specific sensors can be mounted locally or remote, up to 2,500 feet, [750 m] utilizing a #22 gauge stranded, shielded twisted pair cable ONLY must be used.
- DISS gas specific sensor housed in a solid tamper proof enclosure. The Sensor Module is housed in an anodized aluminum and nickle-plated brass enclosure to act as a barrier against any interference.
- The Sensor Module is the smallest computer-calibrated temperature-compensated sensor in the industry.
- True digital LED display and trend indicator for each service monitored.
- Illuminated LED display that is visible at an angle and in dim lighting conditions.
- PSI, kPa or BAR display (switch selected).
- Self diagnostic circuitry with error display for problem identification.
- Highly accurate Solid State Pressure piezo-resistive transducer.
- Adjustable repeat alarm (1 to 60 minutes/or off) for the Compact Alarm.
- Adjustable repeat alarm (1, 12, 24 hours/or off) for the Master Alarm.
- Dry contacts for remote monitoring of High and Low alarm status on the Compact Alarm display module.
- Modules are factory mounted on a hinged frame assembly for ease of installation and maintenance.
- Field programmable push buttons for adjustment of HI and LOW set-points on display module.
- Compact Alarms available from 1 to 12 display modules.
- Master Alarms available in 10 to 60 points.
- Compact Modules can be intermixed with Master Modules to create a combination alarm.
- Built-in relay for remote annunciator applications.
- Compact Module indication for calibration (flashing bar graph).

Description of the Alarm

SHIPMENT DETAILS

When you receive an ALERT-2 series alarm from Amico Corporation, the package will consist of two main sections; the Alarm Back Box and the Frame/Module Assembly. The Frame/Module assembly will be pre-configured, with the appropriate display modules, based upon the customer's specifications.

THE ALARM BACK BOX

The Alarm Back Box contains the auto-switchable System Power Supply with an ON/OFF switch, a built-in fuse and terminal blocks (115 VAC, or 220 VAC). The back box also incorporates the pipe stubs for applications that require locally (in box) mounted sensors.

THE FRAME/MODULE ASSEMBLY

The Frame/Module Assembly consists of the frame and all the modules that are pre-assembled to the customers specification. The hinged frame is designed to swing down from the back box to facilitate installation and servicing of the alarm. This design will reduce installation time and eliminate the risk of improper installation since all the modules are connected and tested at the factory.

Description of the Modules

COMMON TO ALL ALERT-2 ALARMS

SYSTEM POWER SUPPLY

The System Power Supply has been pre-installed into the back box assembly. The System Power Supply converts the AC voltage supply to the alarm into two voltages: 5 VDC (regulated) required by the microprocessor hardware and 15 VDC (unregulated) required by the buzzer and the LED's. This unit also contains the main ON/OFF power switch, the transformer, the heat sink, the main fuse and fuse cover, the rectifying circuitry, the terminal blocks and the low voltage DC power cable for connecting this unit to the annunciator module. The System Power Supply can be easily removed and reinstalled by unscrewing it from the back box.

ANNUNCIATOR MODULE

The Annunciator Module contains the buzzer, a "Power On" LED, the "TEST" and the "ALARM MUTE" buttons. The function of the "TEST" button is to verify that the buzzer and all the LED's are in working condition. An alarm will be heard when this button is pushed and all the LED's will light up. When the button is released, the alarm will silence. The "ALARM MUTE" button is used to silence an alarm that has occurred. This module also contains a fail-safe relay that de-energizes when the buzzer is activated. This relay can be used with the "Amico remote buzzer", for applications requiring a remote audible alarm (see Appendix B), for connection to another Amico Alarm or a Building Management System.

BLANK MODULE

The Blank Module is used as a filler board for future provisions of the alarm.

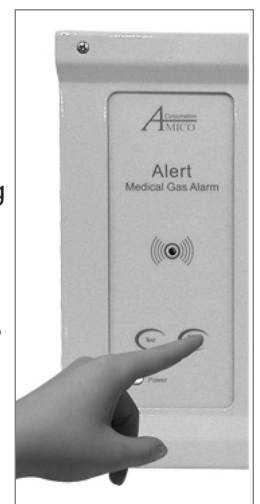
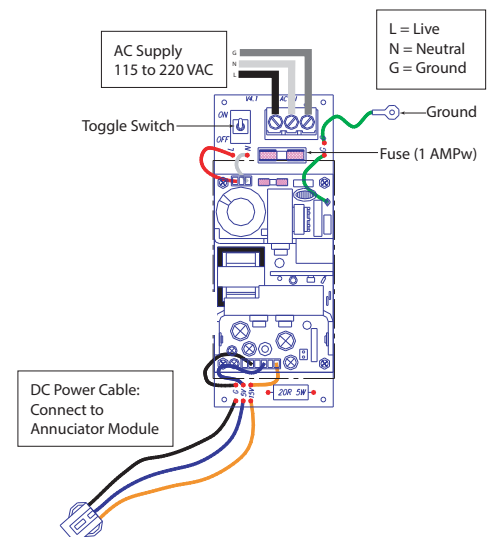

Description of the Modules

COMPACT DISPLAY MODULE

The Compact Module provides a digital display of the actual pressure/vacuum of a gas being monitored. In addition a gas trend indicator bar with High and LOW alarms are displayed. The trend bar as two colored LED's: GREEN for Normal and RED for High and Low condition.

Each display module contains a gas specific colour coded label (USA or ISO colours are available). The Display Module is field adjustable for pressure/vacuum settings, repeat alarm, and unit of measure. Dry contacts for high and low alarms are available for remote monitoring of each module.

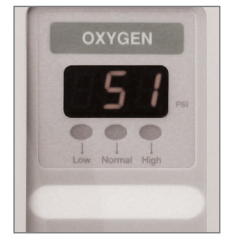

SENSOR MODULE

The Sensor Module contains the transducer which converts the pressure/vacuum pressure source into a digital signal that is displayed on the Display Module. The sensor module shall be housed in an anodized aluminum and nickel-plated brass enclosure to act as a barrier against any interference and it is also temperature compensated. Each sensor is clearly labeled and colour coded for the gas or vacuum being monitored. The sensor module contains a gas specific DISS fitting to ensure correct connection of the proper sensor to the respective gas. Each sensor has been factory calibrated by computer for the specific gas shown on the sensor housing. If it is not connected to the appropriate gas display module, an error message (EO2) will be displayed.



MASTER ALARM

MASTER/NEMA 4 STATUS MODULE

Each Master Status Module will continuously monitor up to 10 signals from source equipment and pressure switches. If any of the signals being monitored go into an alarm condition, a Red LED will illuminate and the audible alarm will sound. The module has a slow and a rapid flashing LED rate. The last alarm condition always flashes at a rapid rate, while the previously acknowledged alarms always flash at a slow rate.

PLEASE NOTE: Contacts located on back of module are Dry Contacts only.

DO NOT apply any voltage.

For Annual Test

- **Reset power to make sure all LED's light up**
- **Push and hold the 'Test' button to light up all LED's and the audible alarm**



COMPUTER INTERFACE MODULE

The Computer Interface Module is a piggyback board that fits on top of the master status module. This module plugs into the status module via a connector, located at the bottom end of the status module. There are three mounting screws provided to secure this module to the status module. This module provides dry contacts for interface to a "Building Management System". The module is "Fail-Safe", closed circuit monitoring.

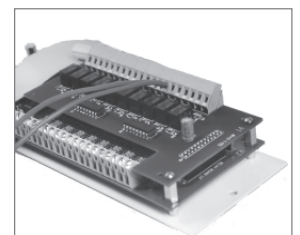

Installation

THE ALARM BOX

Install the back-box to the studs of the wall at the desired height. Ensure that the box is securely in place. The mounting brackets are adjustable to suit the thickness of the wall. **MAKE SURE** the box is parallel, squared and flush with the finished wall surface, to ensure that the frame assembly will fit properly.

FOR LOCAL SENSOR ONLY

If the sensors are to be mounted locally (inside the back box), the pipe stubs must be connected to the pipeline. Using silver-brazing techniques, connect each pipe stub to its appropriate gas or vacuum while ensuring that the bottom of the pipe stub is wrapped with a damp cloth. **BE CAREFUL** not to damage the DISS check-valve by overheating the lower portion of the copper pipe. When the brazing of pipe stubs has been completed, the system can be pressure tested.

STANDING PRESSURE TEST

Perform a standing pressure test on the piping system as per NFPA 99 "Health Care Facilities". Inspect all joints for leaks and make certain each gas is piped to a correspondingly labelled gas service.

FRAME/MODULE ASSEMBLY

- Step #1 Remove the frame/module assembly from its protective box.
- Step #2 Remove screws from the frame section (6 screws).
- Step #3 Attach the flat head screws (provided with frame in plastic bag) to the hinge. This will line up with holes on the box.
- Step #4 Attach the frame wire with 2 dome head screws (provided with frame in plastic bag).
- Step #5 Close the frame panel and tighten the screws on the frame plate.
- Step #6 Carefully place the front frame over the fastened plate. Refasten the screws that were removed in Step #2.

Installation



CAUTION: The microprocessor circuitry on the ALERT-2 alarm contains sophisticated integrated semiconductors. If it becomes necessary to remove a module, PLEASE hold the boards by the edges. **DO NOT TOUCH** any of the components on the board. Static discharge can cause the modules to malfunction, or become damaged.

SENSOR

A. LOCAL (Inside the Back Box)

1. Locate the gas specific sensor module to be installed.
2. In the back box, there are colour coded gas labels located under the DISS Demand check valves. Each label identifies where each sensor module is to be placed.
3. The sensor module contains a gas specific DISS fitting. Push the sensor module hex-nut and nipple adapter up into the demand check-valve. With a wrench, tighten the nut so that it makes a good seal.

NOTE: Pressure on sensors are not to exceed **250 psi** for Pressure sensors and **30"** for vacuum sensors. A failed or damaged filter may allow moisture or water in and damage the transducers.

The new style sensors can read pressure up to:

- Mid Pressure 99 Psi
- Hi Pressure 249 Psi
- Vacuum 30" Hg

B. REMOTE (Outside the Back Box)

1. Connect a Tee (supplied by others) to the pipeline with a 1/4" NPT female connection that will accept the DISS Demand check-valve.
2. Locate the gas specific sensor module to be installed.
3. Thread the DISS Demand check-valve into the correct gas pipe line.
4. The sensor module contains a gas specific DISS fitting. Push the sensor module hex-nut and nipple adapter up into the demand check-valve. With a wrench, tighten the nut so that it makes a good seal.

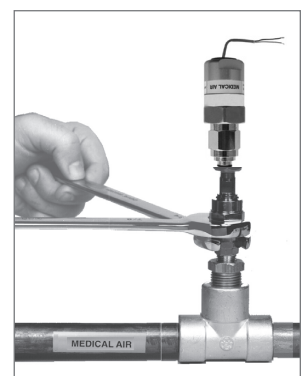

SYSTEM POWER SUPPLY



WARNING: TURN OFF THE POWER SWITCH BEFORE CHANGING ANY MODULES AND/OR DISCONNECTING ANY CABLES, OR ELSE THE FUSE WILL BLOW TO PROTECT THE CIRCUITRY.

1. Ensure that the ON/OFF switch is in the OFF position.
2. Through the top left side of the back box, bring in the AC power wires. Knockouts are provided for making conduit connections to the box. All wiring is to be installed according to local and national codes.
3. Connect the AC power to the terminal blocks as shown in the wiring diagram in Appendix A and as specified in the technical specification in Appendix L and M.

ANNUNCIATOR MODULE

1. The Annunciator Module has a female receptacle located at the top right side of the board (J1).
2. Connect the DC power cable from the System Power Supply into the receptacle connection located on the annunciator module. The connector is keyed and can only be plugged in one way, (Appendix B).

SENSOR MODULE

A. LOCAL (Inside the Back Box)

1. The sensor module is provided with a 6" - 8" [0.1 m - 0.2 m] #22 gauge stranded, shielded twisted pair cable. One wire is Red (positive) and the other wire is Black (negative). Connect the wires to the display module as shown in Appendix D. Take the Red wire from the sensor and attach it to terminal "Sensor +" on the display module. Take the Black wire from the sensor and attach it to terminal "Sensor -". The terminal block on the display module is clearly marked for proper connection of the sensor wires.
2. Repeat the above procedures with the remaining sensor modules.

B. REMOTE (Outside the Back Box)

1. The sensor module is provided with a 6" - 8" [0.1 m - 0.2 m] #22 gauge stranded, shielded twisted pair cable. Connect the wires to a junction box (not supplied) located near the sensor as per the wiring diagram in Appendix E.
2. Connect a shielded twisted pair cable from the junction box to the back box assembly. Knockouts are provided throughout the alarm back box. Up to 2,500 feet [750 m] of #22 gauge, stranded, shielded and twisted pair cable should be used.
3. Connect the Red wire from the cable to the terminal on the display module marked "Sensor +". Connect the black wire to terminal "Sensor -" (see Appendix D).
4. Repeat the above procedures with the remaining sensor modules using the wiring diagram in Appendix E.

Wiring

NOTE: When remote sensors are used, ONLY a #22 gauge stranded, shielded twisted pair cable must be used (BELDEN #8451 or equivalent, supplied by others).

NOTE: Do not ground the shield drain wire at sensor or inside the alarm panel box.

COMPACT DISPLAY MODULE

1. If the dry contacts for high and low are to be used for remote monitoring, connect the wires to the appropriate terminals, Com (Common), NO (Normally Open), NC (Normally Closed), using the diagram in Appendix G.
2. See Appendix L for contact rating.

MASTER/NEMA 4 STATUS MODULE

1. Pull the remote signal wires into the alarm panel. Make the connections to the terminal blocks located on the side of the status module. The wiring is fail-safe normally closed (NC) connections from the source equipment. The signal level is 5 VDC.
2. Make the appropriate wiring connections as per the wiring diagram in Appendix H.
3. For Version 3 and Version 4 ENSURE that the unused terminals in the master module are jumpered. If this is not done, the terminals that have not been jumpered will go into alarm.
4. For Version 4, turn off switches for any unused points (SW2).

COMPUTER INTERFACE MODULE

1. Pull the remote signal wires from the "Building management system" into the alarm panel. Make the connections to the terminal blocks located on the side of the module. The wiring is fail-safe normally open, held closed, dry contacts to the monitoring equipment.
2. Make the appropriate wiring connections as per wiring diagram in Appendix J.

CLOSING THE FRAME/MODULE ASSEMBLY

1. Swing up the frame assembly, ensuring that the stopper wires are folded into the back box.
2. Screw in the frame module to the top of the back box assembly by using the screws provided with the frame/module assembly. The alarm is now ready for use!

Annunciator Module

NOISE LEVEL CONTROL

Factory Default: 80 Decibels

To decrease noise level, locate jumper at J5. Move jumper to:

- LVL1 = 90 dBa.
- LVL2 = 80 dBa.
- LVL3 = 70 dBa.

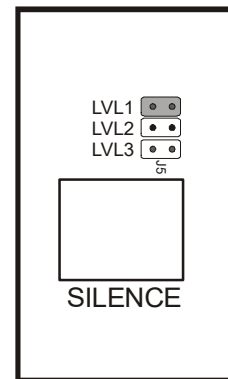

CONTROL OF REMOTE ALARM BUZZER

Factory Default: Normal Condition

To silence remote alarm buzzer, when silencing the annunciator module, locate jumper at J6. Move jumper to:

- NORM = remote alarm buzzer will silence when annunciator module is silenced.
- ALRM = Remote alarm will not silence when annunciator module is silenced. The buzzer will only silence when alarm condition has been cleared. Please refer to Appendix B.

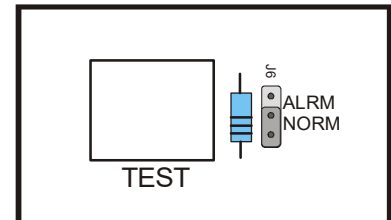

Steps to Re-Calibrate the Sensor from Compact Module

1. Turn on Alarm
2. Set switches #8 & #10 the OFF position
3. Set switches #5 & #6 the ON position
4. The display will show the current reading of the pressure
5. Adjust the calibration, using the "UP" and "DOWN" push buttons, to the desired value.
6. Set switches #5 & #6 the OFF position
7. Turn on #10 if Aims is connected (do not turn on #8)

When you have completed step #7, the display module will automatically go into a "RESET" mode. This will store the data that you had entered.

Compact Display Module - To Change High and Low Pressure Set Points

To change high and low pressure set points, a dip-switch is located on the back of the display module which is used to identify the gas of the display module. The dip-switch contains ten switch settings.

PRESSURE ONLY

Factory Default:

- High = 60 Psi, Low = 40 Psi
- Repeat time = 30 min.

HIGH PRESSURE/NITROGEN

Factory Default:

- High = 195 Psi, Low = 140 Psi
- Repeat time = 30 min.

During programming, the "Trend Bar" will Flash!

1. Set switch #6, #7 and #8 to the ON position.
2. The LED will display (HI-), followed by the current set point. Indicating the system is ready to accept a new High set point. Adjust set point, using the "UP" and "DOWN" push buttons, to the desired value.
3. Set switch #7 to the OFF position.
4. The LED will display (LO-), followed by the current set point. Indicating the system is ready to accept a new Low set point. Adjust set point, using the "UP" and "DOWN" push buttons, to the desired value.
5. Set switch #8 to the OFF position.
6. The LED will display (I-I-), followed by the current set point. Indicating the system is ready to accept a new Repeat time set point. Adjust set point using the "UP" and "DOWN" push buttons, to the desired value. [(Display dd = Disabled) Range from 1 to 60 Minutes]
7. Set switch #6 to the OFF position.

When you have completed step #7, the display module will automatically go into a "RESET" mode. This will store the data that you had entered.

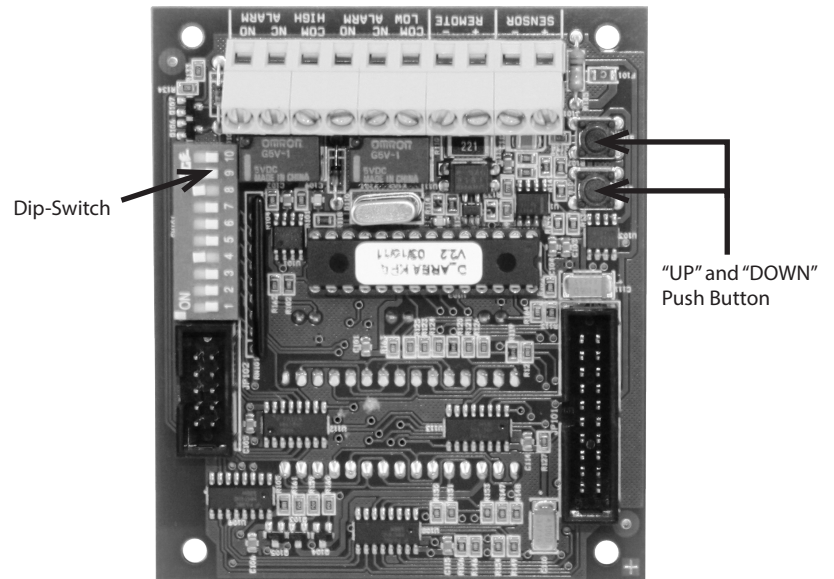

Compact Alarm Board (v 2.02)

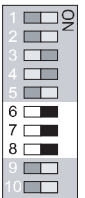

Compact Display Module - To Change High and Low Pressure Set Points

PSI / kPa / BAR Selections

Factory Default - PSI

For PSI mode, set the switch #4 to the ON position. The LED PSI indicator located next to the GAS pressure reading will illuminate.

For kPa mode, set the switch #4 to the OFF position and switch #9 to the ON position. The LED kPa indicator located next to the GAS pressure reading will illuminate.

For BAR set the switch #4 to the OFF and the switch #9 to the OFF position. The LED kPa indicator located next to the GAS pressure reading will illuminate. (There is no separate indicator for BAR).

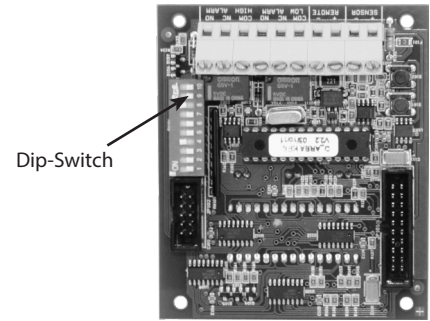

Compact Alarm Board (v 2.02)

VACUUM ONLY

Vacuum alarm set-point adjustment

Factory Default:

- High = 30" Hg, Low = 12" Hg
- Repeat time = 30 min.

During programming, the "Trend Bar" will Flash

1. Set switch #6, #7 and #8 to the ON position.
2. The LED will display (HI-), followed by the current set point. Indicating the system is ready to accept a new High set point. Do not adjust this set point since the High set point is not used.
3. Set switch #7 to the OFF position.
4. The LED will display (LO-), followed by the current set point. Indicating the system is ready to accept a new Low set point. Adjust set point, using the "UP" and "DOWN" push buttons, to the desired value.
5. Set switch #8 to the OFF position.
6. The LED will display (I-I-), followed by the current set point. Indicating the system is ready to accept a new Repeat time set point. Adjust set point using the "UP" and "DOWN" push buttons, to the desired value. [(Display dd=Disabled) Range from 1 to 60 Minutes]
7. Set switch #6 to the OFF position.

When you have completed step #7, the display module will automatically go into a "RESET" mode. This will store the data that you had entered.

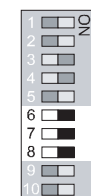
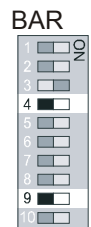
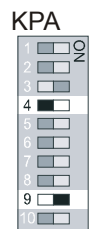
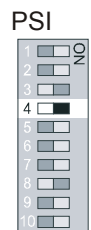

Compact Display Module - To Change High and Low Pressure Set Points

InchHg / KPA / BAR Selections

Factory Default - InchHg

For InchHg mode, set the switch #4 to the ON position. The LED indicating InHg located next to the VACUUM source reading will illuminate.

For KPA mode, set the switch #4 to the OFF position and the switch #9 to the ON position. The LED indicating KPA located next to the VACUUM source reading will illuminate.

For BAR mode, the KPA indicating source must be changed to BAR by use of a label. Set the switch #4 to the OFF and the switch #9 to the OFF position. The LED indicating BAR located next to the VACUUM source reading will illuminate.

COMMON SETTINGS FOR PRESSURE AND VACUUM

Repeat Alarm Enable/Disable

Factory Default - Disable

Disable

Set switch #5 to the OFF position to disable the repeat alarm.

NOTE: When the repeat alarm function is disabled, the alarm will not repeat.

Enable

Enable Mode: (Factory Default 30 min, when enabled).

Set switch #5 to the ON position.

NOTE: The Module with the Lowest set Repeat Time is the one that controls the Repeat Time. For example if one Module is set for 5min and one for 30min and both are Repeat Alarm enabled, the Alarm will now Repeat every 5min.

InchHg

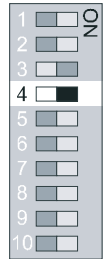

KPA

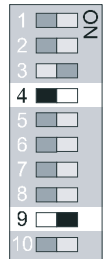

BAR

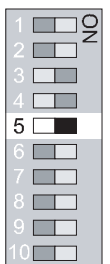
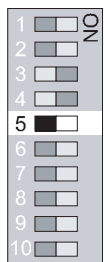
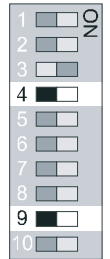

Compact Display Module - To Change High and Low Pressure Set Points

SETTING FACTORY DEFAULT

To quickly reset the module (Pressure or Vacuum) to the factory default settings as follows:

- Pressure: High set-point 60 Psi, Low set-point 40 Psi.
- Nitrogen & HP Air: High set-point 195 Psi, Low set-point 140 Psi.
- Vacuum: Low set-point 12 inchHg.
- No Repeat alarm, but set for 30 min..

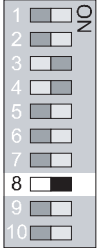

1. Set switch #8 to the ON position.
2. Turn the power off (wait 5 seconds) then back on.
3. Set switch #8 to the OFF position.

The module is now in the default mode.

SETTING GAS IDENTIFICATION SWITCHES

NOTE: DO NOT tamper with switches #1, #2 and #3 on the dip-switch. Tampering with these positions will result in an error message being displayed (EO2) and will disable the electrical interlock from the gas specific sensor.



Changes to these switches should only be done by properly trained personnel, when circuit boards have to be changed in the field.

Switches # 1, #2 and #3 are used for the gas identification of the display module. These will be set at the factory and should not be tampered with in the field.

Chart of Gas Specific Settings of Dip-Switches

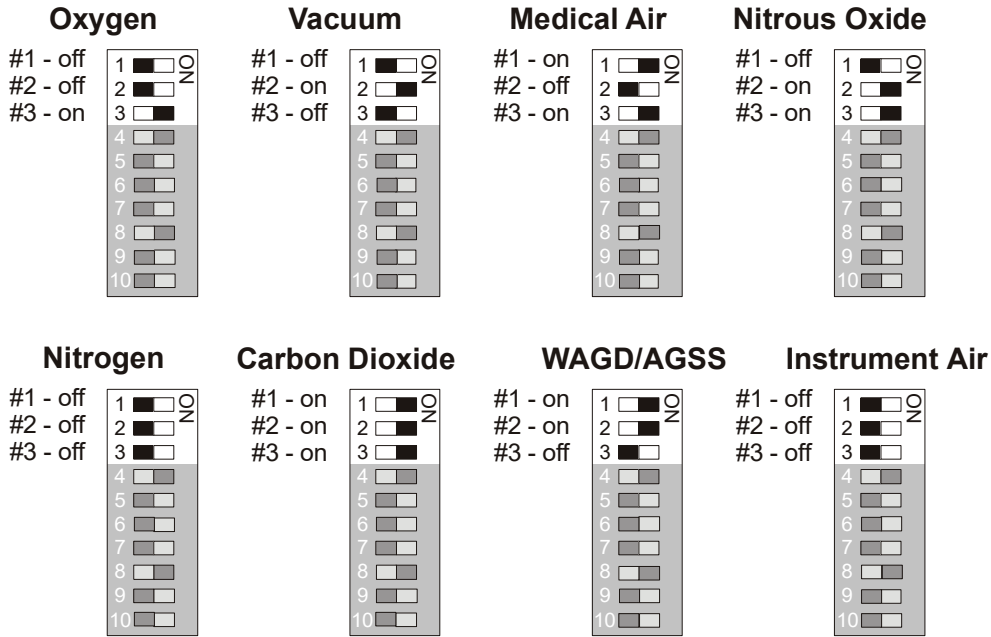

Master/NEMA 4 Status Module

REPEAT ALARM

Factory Default - Disable

Disable		Set switch #1 to the OFF position. Set switch #2 to the OFF position
Enable	1 HR	Set switch #1 to the ON position. Set switch #2 to the OFF position
Enable	12 HR	Set switch #1 to the OFF position. Set switch #2 to the ON position
Enable	24 HR	Set switch #1 to the ON position. Set switch #2 to the ON position.



NOTE: The above repeat alarm only applies to the Master/NEMA 4 alarm.

Master/NEMA 4 Status Module

SIGNAL INPUT SELECTION

Factory Default - Normally Closed as per NFPA 99.

The Amico alarm can detect field devices in the Normally Open or Normally Closed position.

For Normally Closed Set switch #3 to the OFF position.



For Normally Open Set switch #3 to the ON position.



NOTE: The above signal input selection, applies to both alarm systems - the Master/NEMA 4.

MAINTENANCE MODE

Factory Default - Disabled

The Maintenance (or Latch) mode is used to allow hospital personnel to identify loose wiring or faulty source equipment. By putting the master module into "Latch" mode, any alarms received; even transient ones, will be latched-on so that maintenance personnel can identify the source of the problem. The Maintenance mode will disable the automatic reset, if a fault condition has been rectified. The alarm indicator can only be turned-off by pushing the "alarm silence" button on the annunciator module twice. The "Maintenance" LED will illuminate whenever the maintenance mode is enabled.

Disable Set switch #4 to the OFF position.

DISABLE

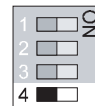

Enable Set switch #4 to the ON position.

ENABLE

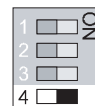

Master/NEMA 4 Status Module

THE MASTER MODULE SWITCH

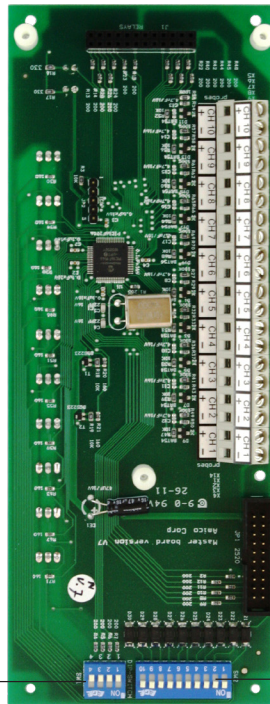

MASTERBOARD 10-CHANNEL ACTIVATION DIP-SWITCHES

The 10 Channel dip-switch is responsible for activating and deactivating each individual corresponding channel on the Masterboard.

NOTE:

Version 4: Jumper any unused points on the Master module.
Turn OFF dip-switches for any unused points (Location SW-2)

ALL CHANNELS ACTIVATED

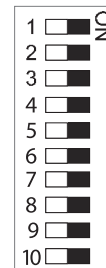

ALL CHANNELS DEACTIVATED

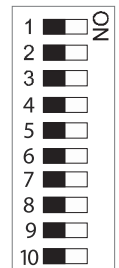

Troubleshooting Guide

Symptom	Cause	Corrective Action
An error code appears on one or more display modules.	The Microprocessor detected a fault and has shutdown.	Turn power switch to OFF position. Wait for at least 5 seconds before turning on the power. The program will reset itself.
	Faulty wire connection between the sensor and display module.	Check error codes at the end of this section.
No power on the alarm. (No LED's illuminated)	AC power not available.	<ol style="list-style-type: none"> 1. Ensure that the ON/OFF switch on the power supply module is turned ON. 2. AC wiring not connected. 3. Check the building electrical breaker to ensure that the power is ON. 4. Check the voltage at the terminal block above the transformer. Ensure that 115 VAC or 220 VAC is being supplied.
	Fuse is blown.	Check the fuse. The fuse is located on the upper-right corner of the system power supply. Replace the fuse if it is defective. See Appendix A and L.
	DC power plug not connected to the annunciator module.	<ol style="list-style-type: none"> 1. Ensure that the DC power plug is firmly in it's socket on the annunciator module. 2. Replace System Power Supply unit if all the above steps fail to resolve the problem.
	Defective Ribbon cable.	Replace the ribbon cable.
Power light on the annunciator module is ON but LED's on other modules are not on.	DC power cable is not connected to the annunciator module.	<ol style="list-style-type: none"> 1. Ensure that the DC power cable is firmly in it's socket on the annunciator module. 2. Ensure that the module(s) on the Frame/Module assembly are all connected to the ribbon cable. 3. Replace the annunciator module.

Troubleshooting Guide

Symptom	Cause	Corrective Action										
No audible alarm and LED's are not illuminating.	DC power cable is disconnected or loose.	<ol style="list-style-type: none"> Ensure that the DC power cable from the system power supply is connected to the annunciator module snugly. <p>Depress "TEST" button. If the LED's come on and there is no audible, replace the annunciator module. If this does not work, try solutions to problem #2.</p>										
Audible signal will not silence.	Faulty display module.	Disconnect the ribbon cable from the back of the faulty display module(s) and replace the module(s).										
	Connection of the DC power cable from system power supply to annunciator module is loose.	Disconnect the DC power cable from the annunciator module and then reconnect. If audible alarm still persists, replace the System Power Supply unit.										
	Faulty annunciator module.	Replace annunciator module.										
Alarm condition exists but LED's are not illuminating.	Display module not properly calibrated.	<ol style="list-style-type: none"> Ensure that the system was properly ordered <p>Factory default settings:</p> <p>Mid Pressure:</p> <table border="0"> <tr> <td>Hi Pressure</td> <td>60 Psi</td> </tr> <tr> <td>Low Pressure</td> <td>40 Psi</td> </tr> </table> <p>Vacuum:</p> <table border="0"> <tr> <td>Low Vacuum</td> <td>12 inHg</td> </tr> </table> <p>High Pressure:</p> <table border="0"> <tr> <td>Hi: Nitrogen & Air</td> <td>195 Psi</td> </tr> <tr> <td>Low: Nitrogen & Air</td> <td>140 Psi</td> </tr> </table> <ol style="list-style-type: none"> If calibration is required, refer to setting HIGH and LOW calibration procedure on page 18/19. 	Hi Pressure	60 Psi	Low Pressure	40 Psi	Low Vacuum	12 inHg	Hi: Nitrogen & Air	195 Psi	Low: Nitrogen & Air	140 Psi
	Hi Pressure	60 Psi										
Low Pressure	40 Psi											
Low Vacuum	12 inHg											
Hi: Nitrogen & Air	195 Psi											
Low: Nitrogen & Air	140 Psi											
Faulty display module.	Replace the display module.											
Gas reading incorrect.	Loose connection of DISS fittings.	Ensure that the sensor module is properly connected to the DISS demand check-valve.										
	Sensor module is not properly wired to the display module.	Ensure that the sensor module is properly wired to the display module by using wiring diagram in Appendix D or E.										
	Defective sensor or requires calibration.	Replace the sensor module.										
	The ribbon cable not properly connected to the display module.	Pull out the ribbon cable and connect it back in again, while ensuring that it is seated properly.										
	Defective display module.	Replace the display module.										

Error Code Messages on the Display Module

System	Cause	Corrective Action	Page
E00 or E01	No sensor is connected or wires are not connected properly on terminals.	Connect a sensor and check the wiring.	33 / 34
E02	Sensor and Display Module mismatched.	Ensure that the Sensor and Display Module are for the same gas.	14
E03	The High set-point was set below the Low set-point or vice versa.	Recalibrate the High and Low setpoint to proper values.	10 / 11
E04	Incorrect type of Sensor connected, (i.e. 250 Psi sensor on a 100 Psi range).	Connect the correct Sensor to the matching Display Module.	
E06	Cable between the sensor and display module shorted out or reversed polarity.	Reverse polarity or replace cable if defective.	33 / 34
E07	Out of Calibration / Sensor not reading gas	Replace the sensor module	33 / 34

NOTE: For any other error codes, swap the sensor or circuit board to isolate the issue with the board or sensor.

Model Numbers

MASTER ALARM



10 functions = A2M-E-10
4 gang back box



40 functions = A2M-E-40
7 gang back box



20 functions = A2M-E-20
4 gang back box

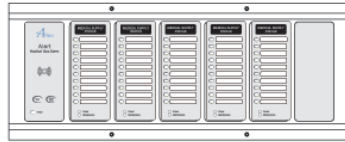

50 functions = A2M-E-50
7 gang back box



30 functions = A2M-E-30
4 gang back box

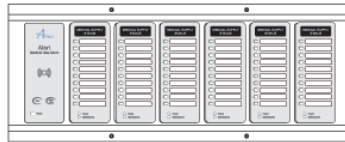

60 functions = A2M-E-60
7 gang back box

C = Conversion

A2M(C)-L-20

The Letter "L" Represents the Language:

- E = English (CSA/NFPA)
- F = French (CSA)
- S = Spanish (NFPA)

Example: 2 Modules, English (20 Functions) = A2M-E-20

NEMA 4 ALARM



10 Points

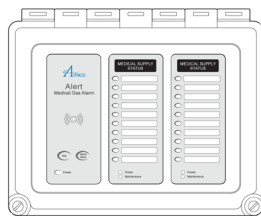

20 Points

N = Nema

A2MN-L-XX

The Letter "L" Represents the Language:

- E = English (CSA/NFPA)
- F = French (CSA)
- S = Spanish (NFPA)

The Letters "XX" Define the Number of Functions:

- 10 = 10 Functions
- 20 = 20 Functions

Model Numbers

COMPACT ALARM

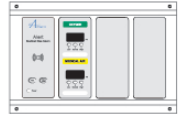

2 module = A2DRU-XX
4 gang back box



4 modules = A2DRU-XXXX
4 gang back box

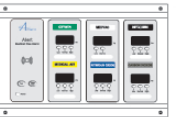

6 modules = A2DRU-XXXXXX
4 gang back box



8 modules = A2DRU-XXXXXXXX
7 gang back box

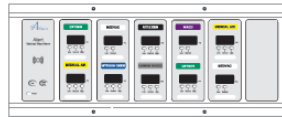

10 modules = A2DRU-XXXXXXXXXX
7 gang back box



12 modules = A2DRU-XXXXXXXXXXXX
7 gang back box

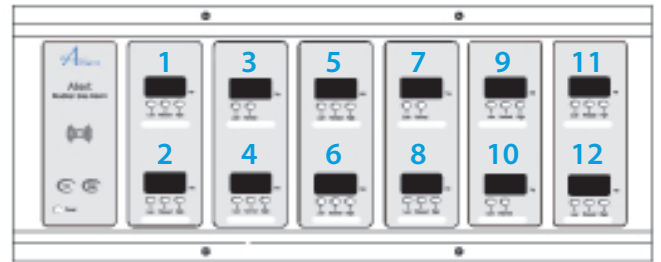
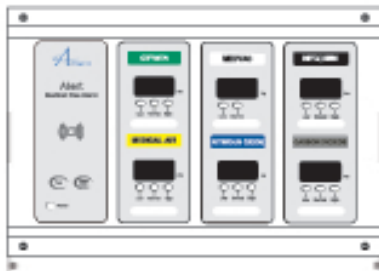

"X" indicates the order of gases, as shown above.

Example: English NFPA - Oxygen, Medical Air, MedVac, Nitrous Oxide, Nitrogen, Carbon Dioxide = A2DRU-OAV2NC

R = Remote/Local Sensors
C = Conversion Series

A2DRU-XXXXXXXXXXXX

The Letter "U" Represents the Language:

- U = English (NFPA)
- E = English (CSA)
- F = French (CSA)
- S = Spanish (NFPA)

The Letter "X" Defines the Type of Gas:

- O = Oxygen
- A = Medical Air
- V = MedVac
- 2 = Nitrous Oxide
- N = Nitrogen
- C = Carbon Dioxide
- W = WAGD
- E = AGSS
- I = Instrument Air

Model Numbers

COMPACT MASTER COMBINATION ALARM

Use the Model number for the Area Alarm and add "M" for each Master module.

Example: 3 Gases, English ISO, Remote/Local Sensors, Oxygen, Vacuum, Medical Air and 2 Master Modules = A2DRE-OVAMM.

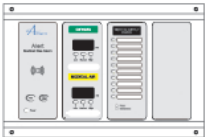

2 modules = A2DRU-XXM
4 gang back box



4 modules = A2DRU-XXXXMM
7 gang back box

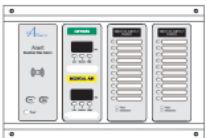

3 modules = A2DRU-XXMM
4 gang back box

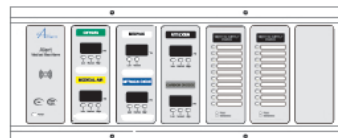

5 modules = A2DRU-XXXXXMM
7 gang back box

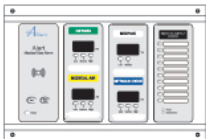

3 modules = A2DRU-XXXXM
4 gang back box

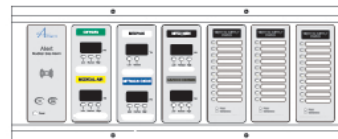

6 modules = A2DRU-XXXXXMM
7 gang back box

NOTE: Please specify the gang back box on each alarm

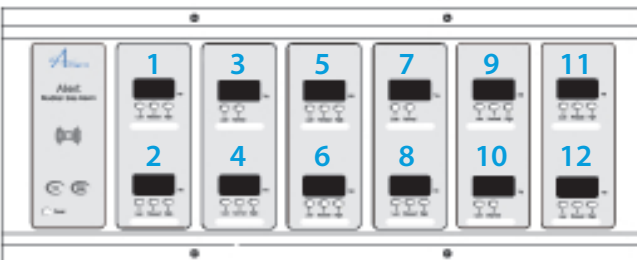

Each "M" Stands for
10 Functions

A2DRU-XXXXXMMM

R = Remote/Local Sensors
C = Conversion

The Letter "L" Represents
the Language:

U = English (NFPA)
E = English (CSA)
F = French (CSA)
S = Spanish (NFPA)

The Letter "X" Defines
the Type of Gas:

O = Oxygen
A = Medical Air
V = MedVac
2 = Nitrous Oxide
N = Nitrogen
C = Carbon Dioxide
W = WAGD
E = AGSS
I = Instrument Air

Spare Part Numbers

Model Number	Description
A2-MAN-ALM-ENG	Alert-2 alarm manual English
A2P-ANNU-CB	Annunciator circuit board assembly
A2P-ANNU-EB	Annunciator module English Alert-2
A2P-POWER-V2	Power supply module Alert-2
A2P-SENS-E-AIR	Sensor module ISO-AIR Eng. Alert-2
A2P-SENS-E-CO2	Sensor module ISO-CO2 Eng. Alert-2
A2P-SENS-E-EVA	Sensor module ISO-EVA Eng. Alert-2
A2P-SENS-E-N2O	Sensor module ISO-N2O Eng. Alert-2
A2P-SENS-E-NIT	Sensor module ISO-NIT Eng. Alert-2
A2P-SENS-E-OXY	Sensor module ISO-OXY Eng. Alert-2
A2P-SENS-E-VAC	Sensor module ISO-VAC Eng. Alert-2
A2P-SENS-E-IAR	Sensor module ISO-IAR Eng. Alert-2
A2P-SENS-U-IAR	Sensor module ISO-USA-IAR Eng. Alert-2
A2P-SENS-U-AIR	Sensor module USA-AIR Eng. Alert-2
A2P-SENS-U-ARG	Sensor module USA-ARGON Eng. Alert-2
A2P-SENS-U-HEL	Sensor module USA-HEL Eng. Alert-2
A2P-SENS-U-HEO	Sensor module USA-HELIOX Alert-2
A2P-SENS-U-OXY	Sensor module USA-OXY Eng. Alert-2
A2P-SENS-U-VAC	Sensor module USA-VAC Eng. Alert-2
A2P-SENS-U-WAG	Sensor module USA-WAG Eng. Alert-2
A2P-MAST-E-AME	Master alarm module - English 10 points
A2P-MAST-CB	Master circuit board Assembly Alert-2
A2P-BLANK	Alert-2 alarm module blank (filler)
A2P-BOXASS-4	Alarm back box Assembly 4-station Alert-2
A2P-BOXASS-7	Alarm back box Assembly 7-station Alert-2
A2P-COMP-10	Computer interface Module English 10-pts.
A2P-FRMASS-4B	Alarm frame assembly 4-station Alert-2
A2P-FRMASS-7B	Alarm frame assembly 7-station Alert-2
A2P-RIB-COMP-07	RIBBON CABLE ASSY 3 STN COMPACT ALARM
A2P-RIB-COMP-13	RIBBON CABLE ASSY 6 STN COMPACT ALARM
A2P-COMPAC-CB	Compact Circuit Board Assembly-All Gases
A2P-MYLCPB-E-AGS	Compact Board Mylar Bottom (ISO) - AGS
A2P-MYLCPB-E-AIR	Compact Board Mylar Bottom (ISO) - AIR
A2P-MYLCPB-E-CO2	Compact Board Mylar Bottom (ISO) - CO2
A2P-MYLCPB-E-N2O	Compact Board Mylar Bottom (ISO) - N2O
A2P-MYLCPB-E-NIT	Compact Board Mylar Bottom (ISO) - NIT
A2P-MYLCPB-E-OXY	Compact Board Mylar Bottom (ISO) - OXY
A2P-MYLCPB-E-VAC	Compact Board Mylar Bottom (ISO) - VAC
A2P-MYLCPB-E-IAIR	Compact Board Mylar Bottom (ISO) -IAIR
A2P-MYLCPB-U-AIR	Compact Board Mylar Bottom (NFPA) - AIR
A2P-MYLCPB-U-OXY	Compact Board Mylar Bottom (NFPA) - OXY
A2P-MYLCPB-U-VAC	Compact Board Mylar Bottom (NFPA) - VAC
A2P-MYLCPB-U-WAG	Compact Board Mylar Bottom (NFPA) - WAG
A2P-MYLCPB-U-IAIR	Compact Board Mylar Bottom (NFPA) - IAIR

Spare Part Numbers

Model Number	Description
A2P-MYLCPT-E-AGS	Compact Board Mylar Top (ISO) - AGS
A2P-MYLCPT-E-AIR	Compact Board Mylar Top (ISO) - AIR
A2P-MYLCPT-E-CO2	Compact Board Mylar Top (ISO) - CO2
A2P-MYLCPT-E-N2O	Compact Board Mylar Top (ISO) - N2O
A2P-MYLCPT-E-NIT	Compact Board Mylar Top (ISO) - NIT
A2P-MYLCPT-E-OXY	Compact Board Mylar Top (ISO) - OXY
A2P-MYLCPT-E-VAC	Compact Board Mylar Top (ISO) - VAC
A2P-MYLCPT-E-IAIR	Compact Board Mylar Top (ISO) - IAIR
A2P-MYLCPT-U-AIR	Compact Board Mylar Top (NFPA) - AIR
A2P-MYLCPT-U-OXY	Compact Board Mylar Top (NFPA) - OXY
A2P-MYLCPT-U-VAC	Compact Board Mylar Top (NFPA) - VAC
A2P-MYLCPT-U-WAG	Compact Board Mylar Top (NFPA) - WAG
A2P-MYLCPT-U-IAIR	Compact Board Mylar Top (NFPA) - IAIR
A2P-MYLCP-BLNK	Compact Board Mylar - Top Display and Bottom Blank
A2P-MYLCP-COVER	Compact Board Mylar - Top and Bottom Display
A2P-COMPAC-T-E-AGS	COMPACT TOP AREA BOARD AGSS – ENG
A2P-COMPAC-B-E-AGS	COMPACT BOTTOM AREA BOARD AGSS – ENG
A2P-COMPAC-T-E-AIR	COMPACT TOP AREA BOARD AIR – ENG
A2P-COMPAC-B-E-AIR	COMPACT BOTTOM AREA BOARD AIR – ENG
A2P-COMPAC-T-E-CO2	COMPACT TOP AREA BOARD CO2 - ENG
A2P-COMPAC-B-E-CO2	COMPACT BOTTOM AREA BOARD CO2 – ENG
A2P-COMPAC-T-E-IAR	COMPACT TOP AREA BOARD INST AIR- ENG
A2P-COMPAC-B-E-IAR	COMPACT BOTTOM AREA BOARD INST AIR- ENG
A2P-COMPAC-T-E-N2O	COMPACT TOP AREA BOARD N2O - ENG
A2P-COMPAC-B-E-N2O	COMPACT BOTTOM AREA BOARD N2O – ENG
A2P-COMPAC-T-E-NIT	COMPACT TOP AREA BOARD NIT - ENG
A2P-COMPAC-B-E-NIT	COMPACT BOTTOM AREA BOARD NIT – ENG
A2P-COMPAC-T-E-OXY	COMPACT TOP AREA BOARD OXY - ENG
A2P-COMPAC-B-E-OXY	COMPACT BOTTOM AREA BOARD OXY – ENG
A2P-COMPAC-T-E-VAC	COMPACT TOP AREA BOARD VAC - ENG
A2P-COMPAC-B-E-VAC	COMPACT BOTTOM AREA BOARD VAC - ENG
A2P-COMPAC-T-U-AIR	COMPACT TOP AREA BOARD AIR -US
A2P-COMPAC-B-U-AIR	COMPACT BOTTOM AREA BOARD AIR –US
A2P-COMPAC-T-U-ARG	COMPACT TOP AREA BOARD ARG -US
A2P-COMPAC-B-U-ARG	COMPACT BOTTOM AREA BOARD ARG –US
A2P-COMPAC-T-U-IAR	COMPACT TOP AREA BOARD INST AIR- US
A2P-COMPAC-B-U-IAR	COMPACT BOTTOM AREA BOARD INST AIR- US
A2P-COMPAC-T-U-OXY	COMPACT TOP AREA BOARD OXY -US
A2P-COMPAC-B-U-OXY	COMPACT BOTTOM AREA BOARD OXY –US
A2P-COMPAC-T-U-VAC	COMPACT TOP AREA BOARD VAC -US
A2P-COMPAC-B-U-VAC	COMPACT BOTTOM AREA BOARD VAC –US
A2P-COMPAC-T-U-WAG	COMPACT TOP AREA BOARD WAG -US
A2P-COMPAC-B-U-WAG	COMPACT BOTTOM AREA BOARD WAG -US

Spare Part Numbers

DISS KITS

Model Number	Description
S-DIS-KIT-OXY	DISS Demand Check, Nut and Nipple - OXY
S-DIS-KIT-AIR	DISS Demand Check, Nut and Nipple- AIR
S-DIS-KIT-VAC	DISS Demand Check, Nut and Nipple- VAC
S-DIS-KIT-N2O	DISS Demand Check, Nut and Nipple - N2O
S-DIS-KIT-NIT	DISS Demand Check, Nut and Nipple - NIT
S-DIS-KIT-EVA	DISS Demand Check, Nut and Nipple- WAG/AGS
S-DIS-KIT-IAR	DISS Demand Check, Nut and Nipple - IAR
S-DIS-KIT-CO2	DISS Demand Check, Nut and Nipple - CO2

RETRO-FIT-PARTS

Model Number	Description
A3P-POWER-V4	Alert-3 Power Supply Module - Ver.4
A2P-BOX-4-FILL	AL-2/3 Alarm Box Filler Frame 4-Station
A2P-BOX-7-FILL	AI-2/3 Alarm Box Filler Frame 7-Station
A2P-CONKIT-GANG-4	For 4 Gang Conv Trim Plate 4
A2P-CONKIT-GANG-5	For 5 Gang Conv Trim Plate 5
A2X-P-CON-FTUBE	AI-2/3 Conv. Sensor Flexible Tubing
A2P-CONKIT-CHEAN-1	Conv For 1 Gas Chem/Ncg Ana Medstar/Oxeq
A2P-CONKIT-CHEDI-1	Conv For 1 Gas Chem/Ncg/Allied Digital
A2P-CONKIT-MEDINT-1	Conv 1 Gas Medase/OHM/Medplus/Alert-1
A2P-CONKIT-OHI-1	Conv For 1 Gas Ohio/OHM Beige Digi/Ana
A2P-CONKIT-PBSER-1	Conv For 1 Gas Puritan Benet Series
A2P-CONKIT-SQUCOG-1	Conv For 1 Gas Squire Cogswell/ Product
A2P-CONKIT-TRITEC-1	Conv 1 Gas Tri-Tech/Beconmedes/PB Mega

DEMAND CHECK VALVES

Model Number	Description
S-DIS-DEMC-AIR	DISS Demand Check Valve 1/4" MNPT - AIR
S-DIS-DEMC-CO2	DISS Demand Check Valve 1/4" MNPT - CO2
S-DIS-DEMC-NIT	DISS Demand Check Valve 1/4" MNPT - NIT
S-DIS-DEMC-N2O	DISS Demand Check Valve 1/4" MNPT - N2O
S-DIS-DEMC-EVA	DISS Demand Check Valve 1/4" MNPT - EVA
S-DIS-DEMC-OXY	DISS Demand Check Valve 1/4" MNPT - OXY
S-DIS-DEMC-VAC	DISS Demand Check Valve 1/4" MNPT - VAC
S-DIS-DEMC-IAR	DISS Demand Check Valve 1/4" MNPT - IAR

Dimensions

MASTER ALARM

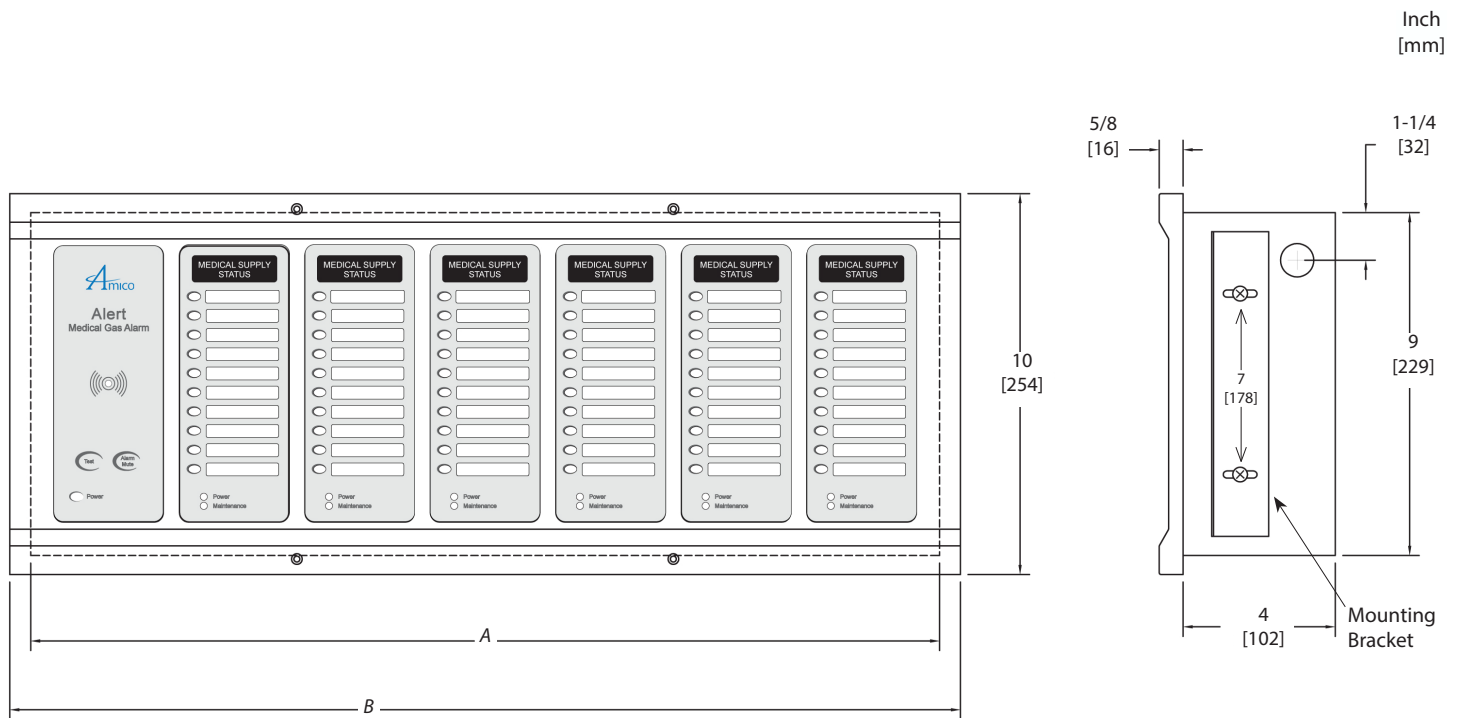

Number of Display Modules	A	B	Gang
From 1 to 3 modules	14 (356)	15 (381)	4
From 1 to 6 modules	24 (610)	25 (635)	7

Dimensions

COMPACT ALARM

Inch
[mm]

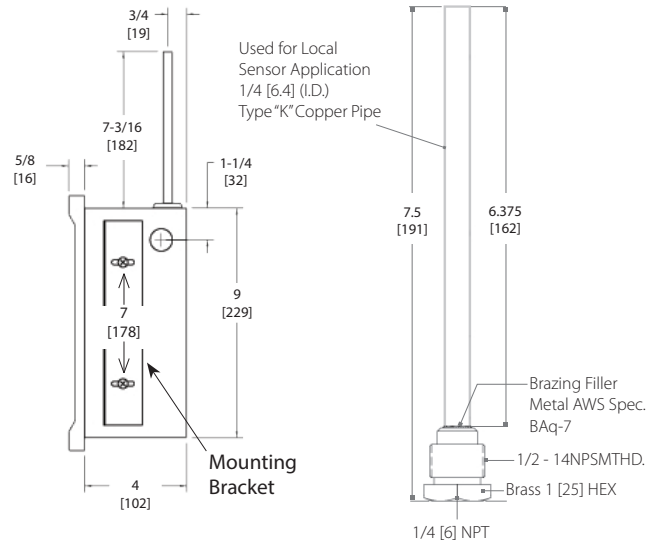
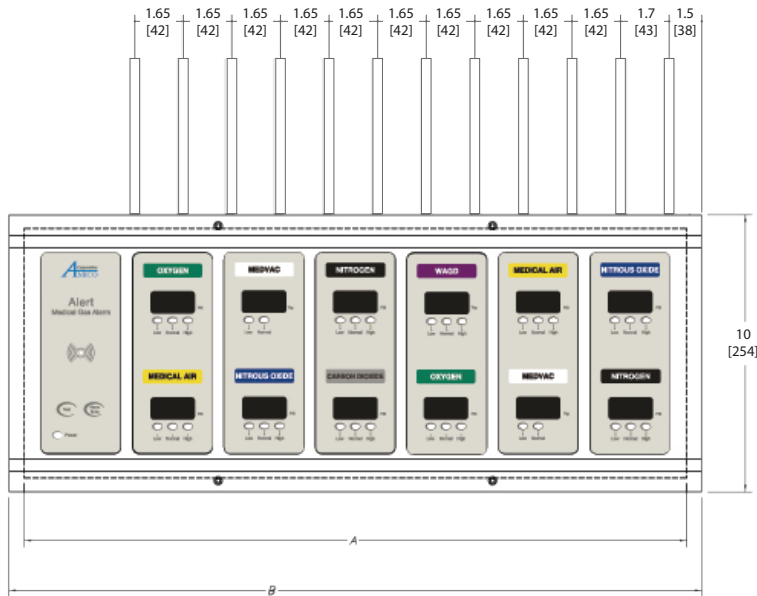

Number of Display Modules	A	B	Gang
From 1 to 3 modules	14 (356)	15 (381)	4
From 1 to 6 modules	24 (610)	25 (635)	7

Local/Remote Sensor

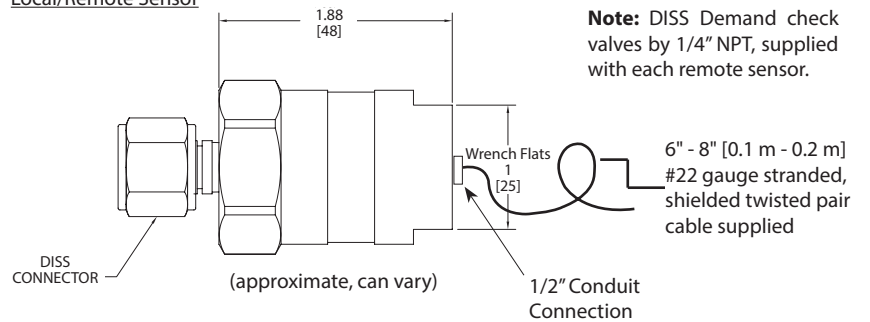

1/2"-14 NPSM [13]
(see Thread Specs.)

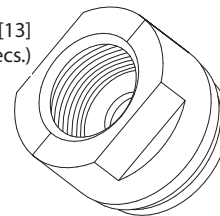

Dimensions

COMPACT MASTER COMBINATION ALARM

Inch
[mm]

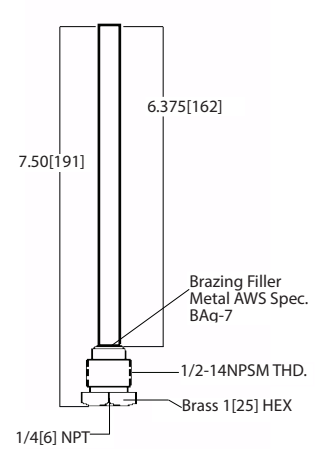
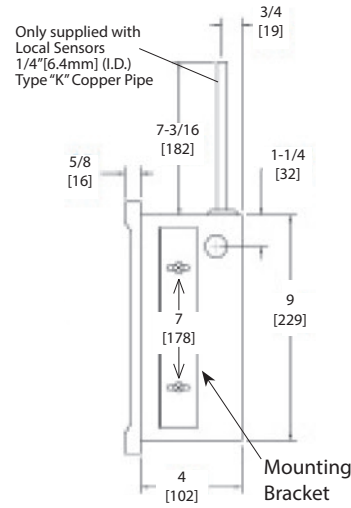
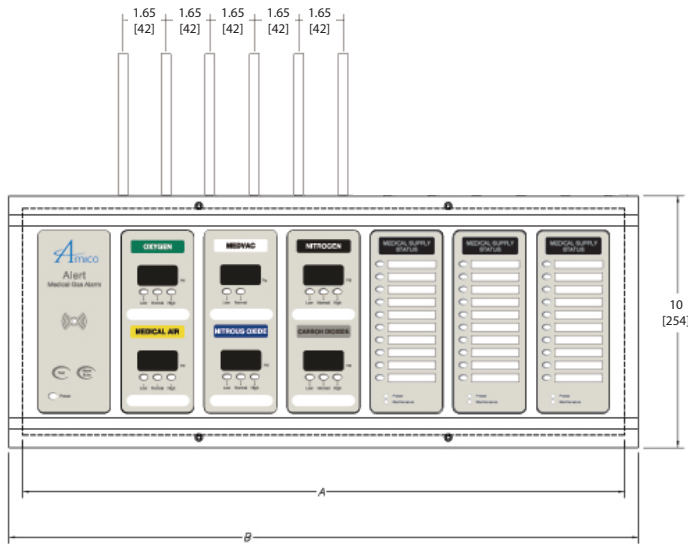

Number of Display Modules	A	B	Gang
From 1 to 3 modules	14 (356)	15 (381)	4
From 1 to 6 modules	24 (610)	25 (635)	7

Local/Remote Sensor

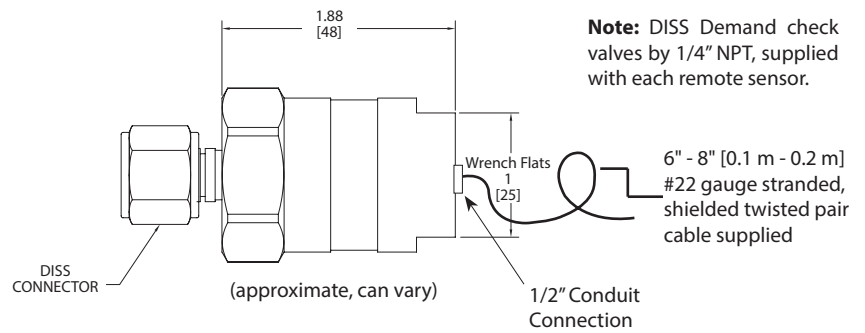

Note: DISS Demand check valves by 1/4" NPT, supplied with each remote sensor.

1/2"-14 NPSM [13]
(see Thread Specs.)

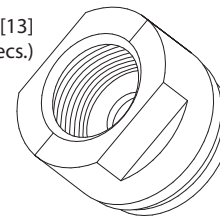

Dimensions

NEMA 4 ALARM

Inch
[mm]

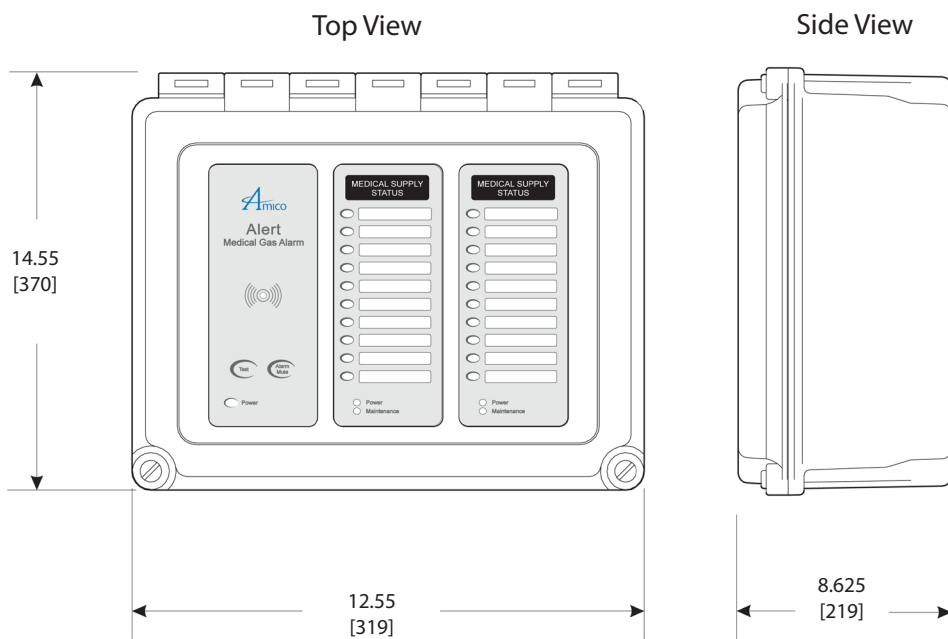
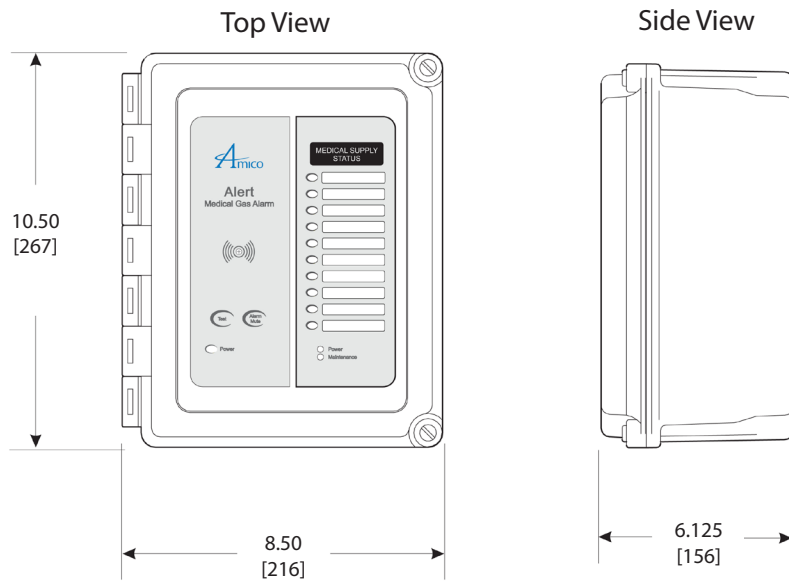

Appendix A

WIRING DIAGRAM: AUTO-SWITCHING POWER SUPPLY

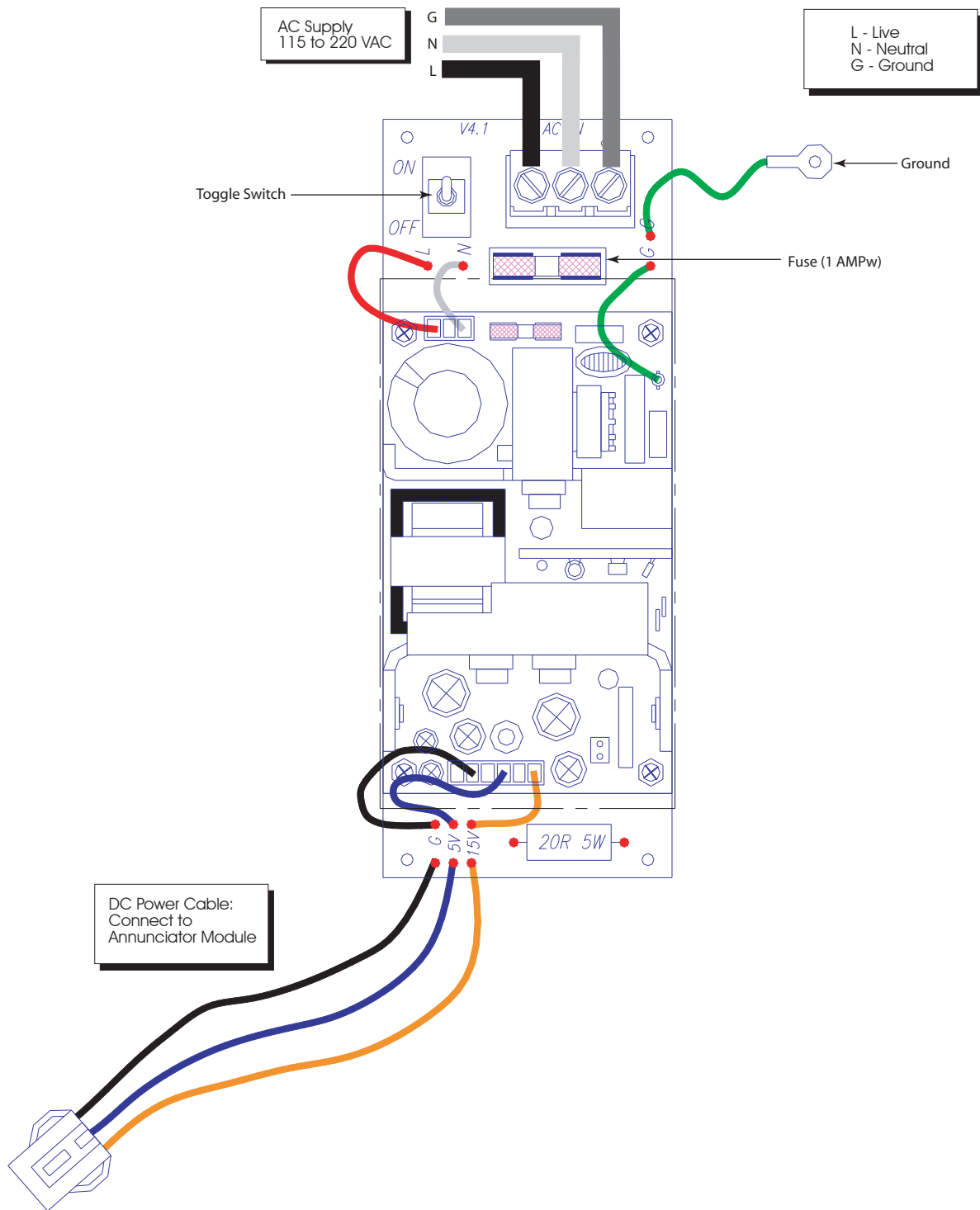

1. Verify that the power has been switched off prior to working on the alarm.
2. Risk of electric shock, disconnect power at the circuit breaker before removing the power supply shield.

Appendix B

WIRING DIAGRAM: ANNUNCIATOR

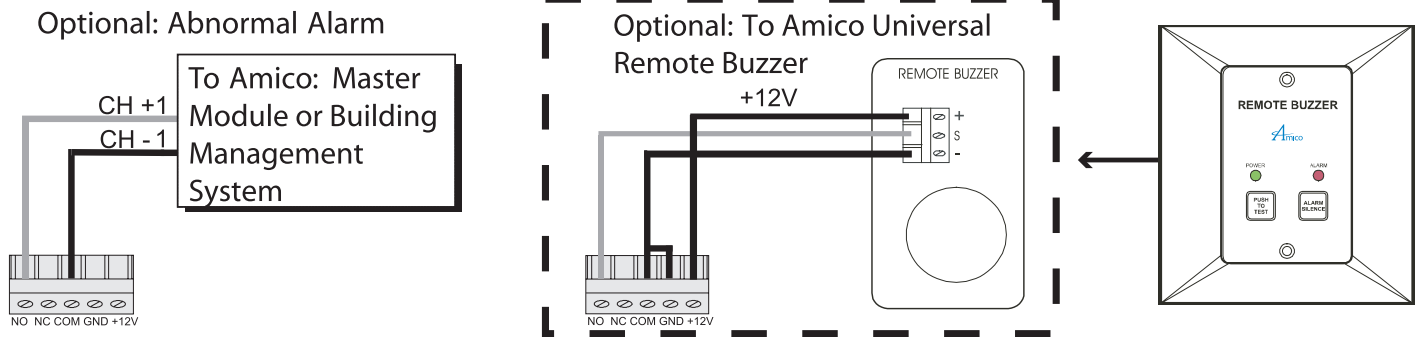

NOTE: Amico recommends max. 50 ft. to power up buzzer from any Amico devices (alarm/manifold). More than 50 ft., a A3P-Power-V4 is required to supply voltage for the manifold buzzer.

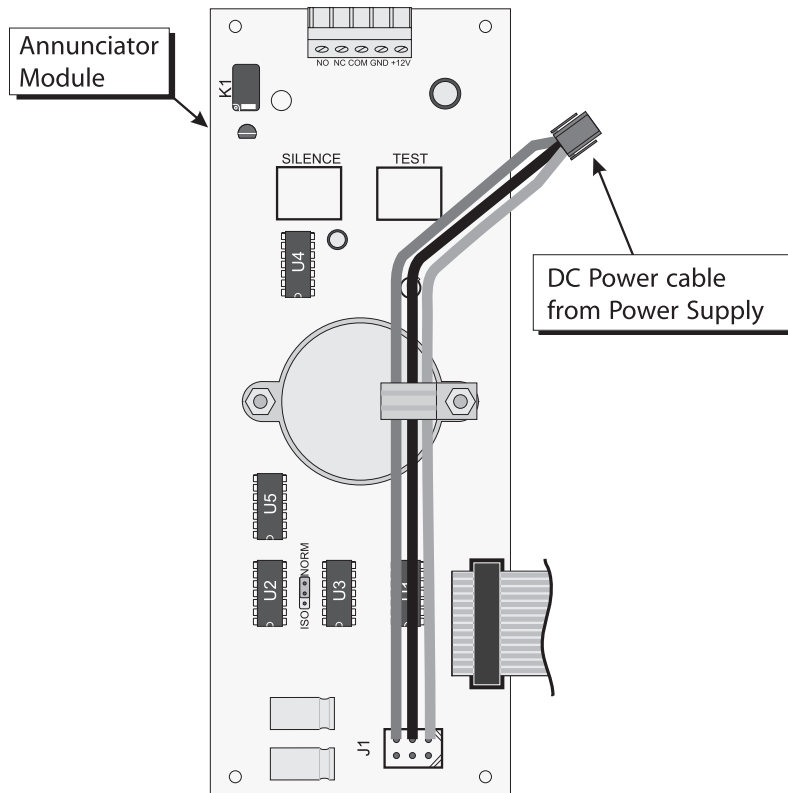

Appendix C

WIRING DIAGRAM: AUTOMATIC VOICE/PAGER DIALING SYSTEM

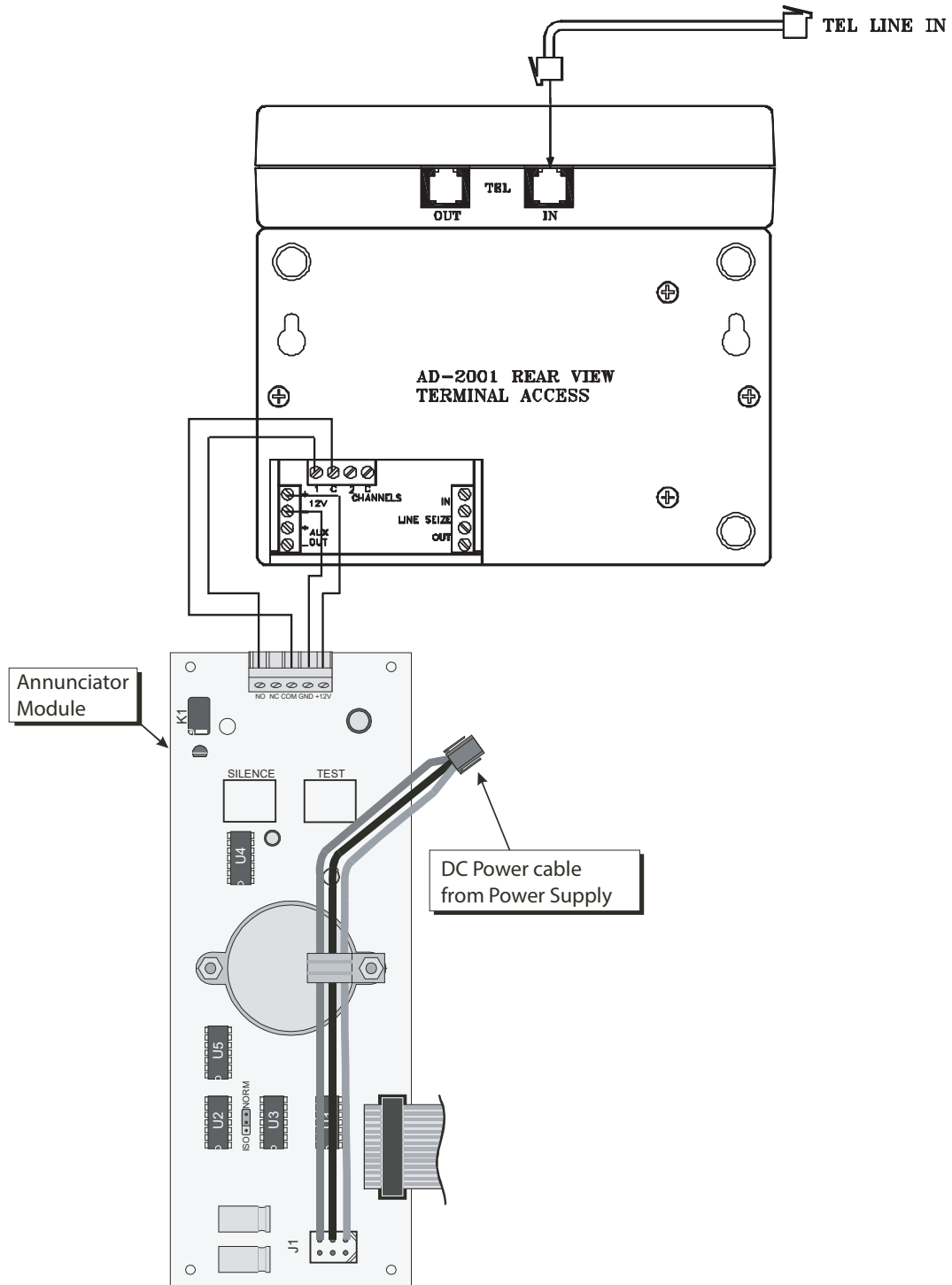

Appendix D

WIRING DIAGRAM: COMPACT DISPLAY MODULE - LOCAL SENSOR

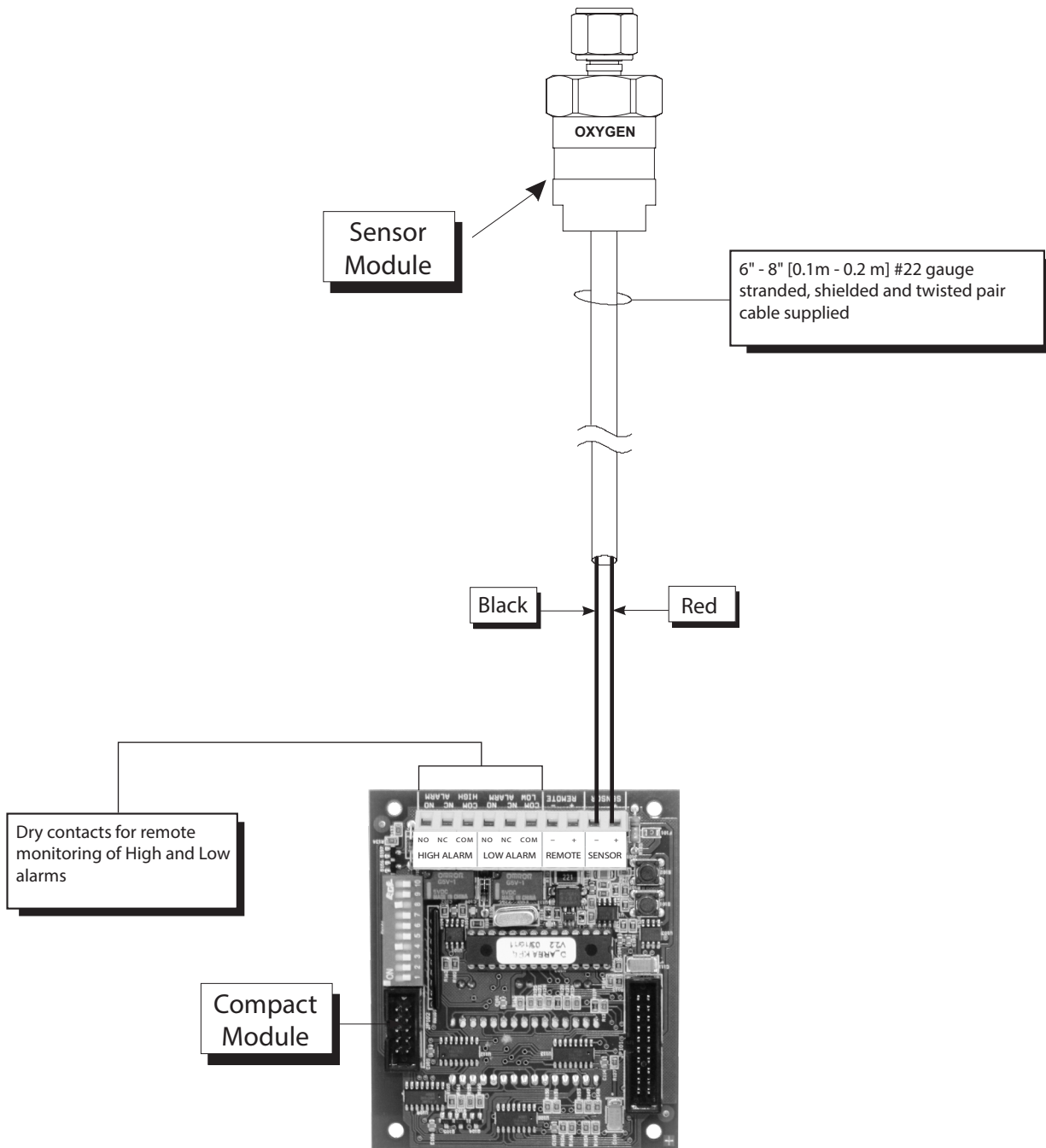

NOTE: Do not ground the shield drain wire at sensor or inside alarm panel back box.



To protect from static electricity, ensure to discharge body static before installing the Medical Gas Alarm and Sensors.

Appendix E

WIRING DIAGRAM: COMPACT DISPLAY MODULE - REMOTE SENSOR

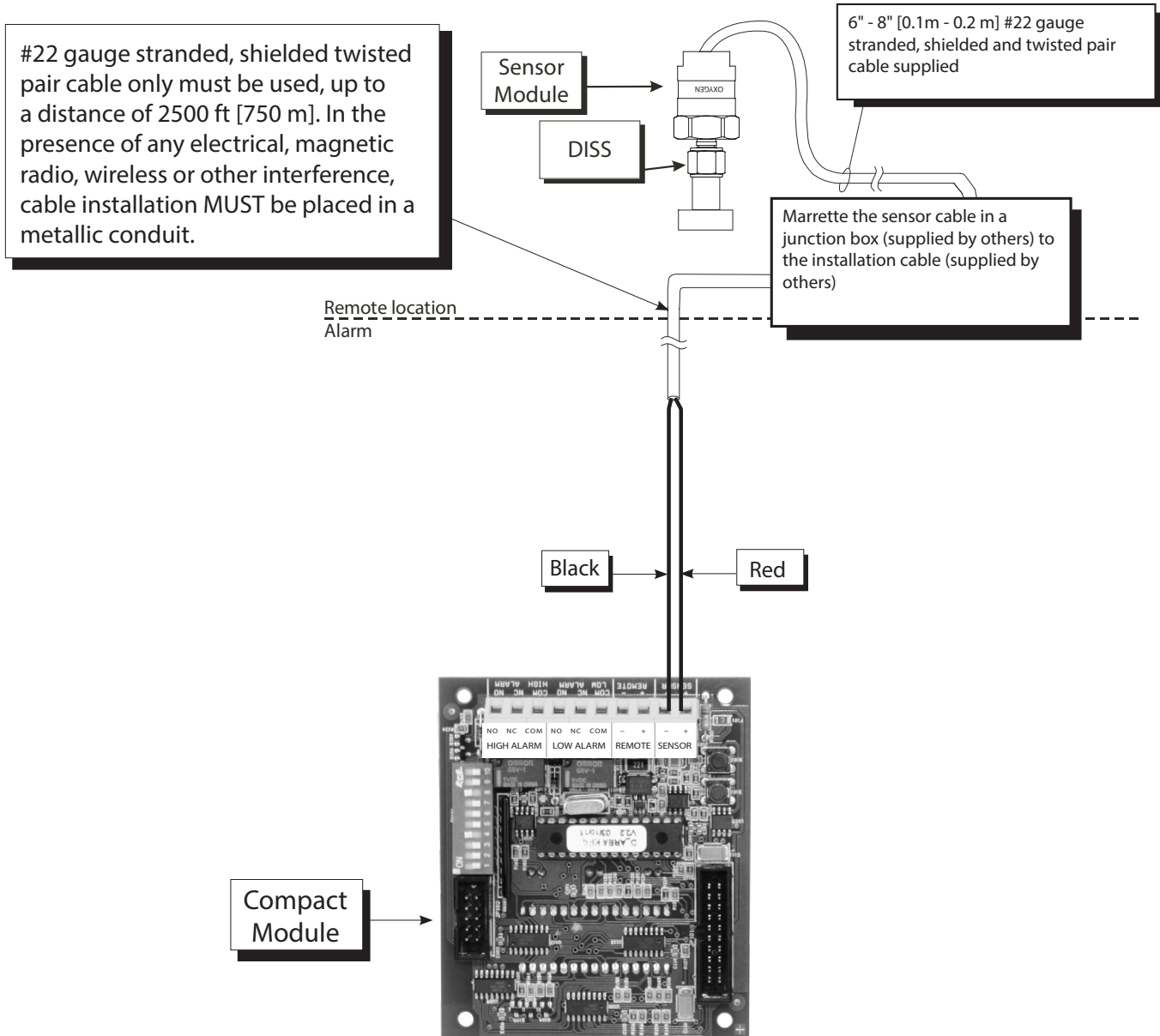

NOTE: For multiple sensors, a multi-conductor #22 gauge stranded, shielded and twisted pair cable ONLY must be used.

Appendix F

WIRING DIAGRAM: COMPACT MODULE TO MASTER

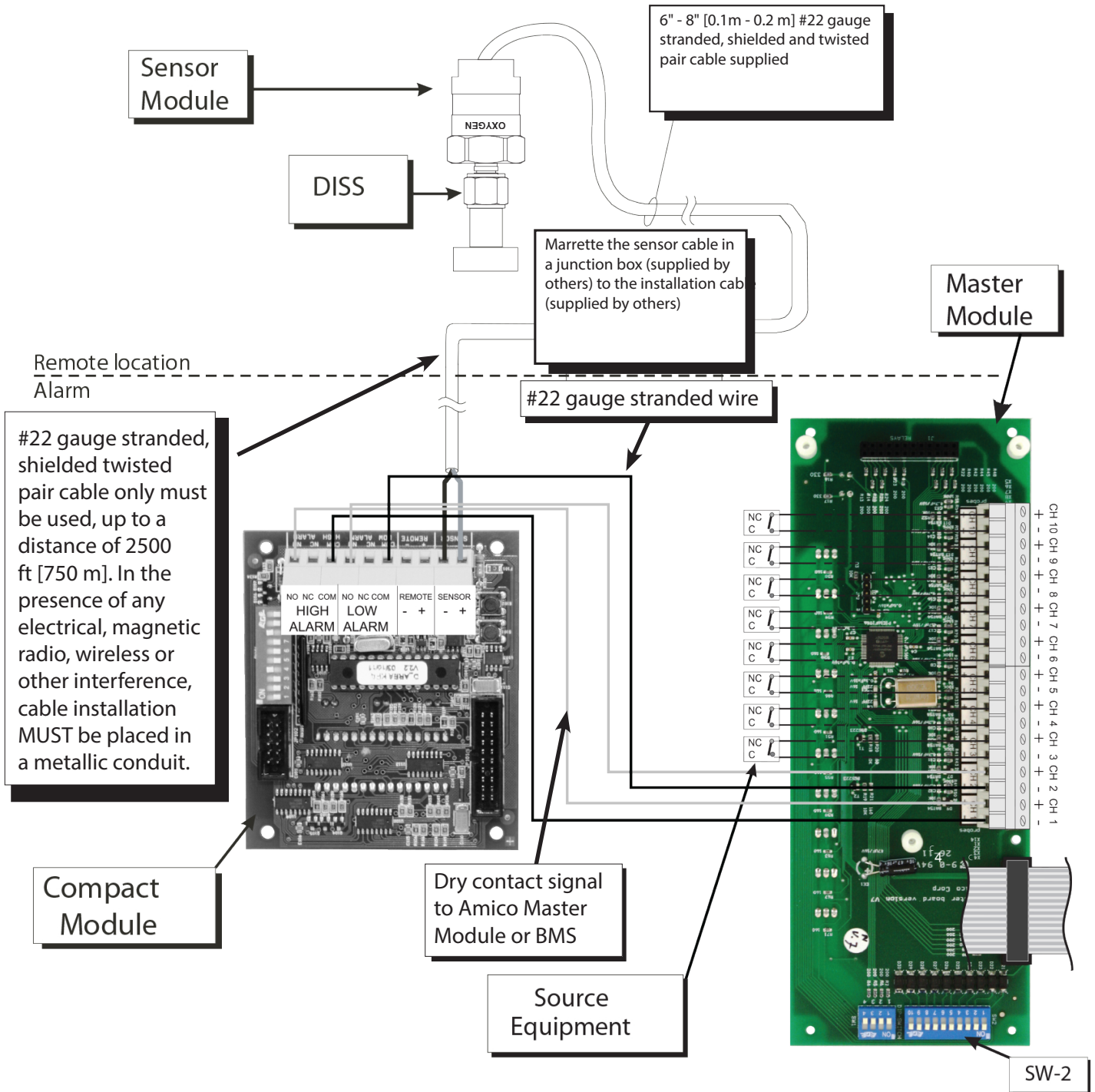

NOTE: Jumper any unused points on the Master module.

Turn OFF dip-switches for any unused points (Location SW-2).

Appendix G

WIRING DIAGRAM: ABNORMAL CONDITION

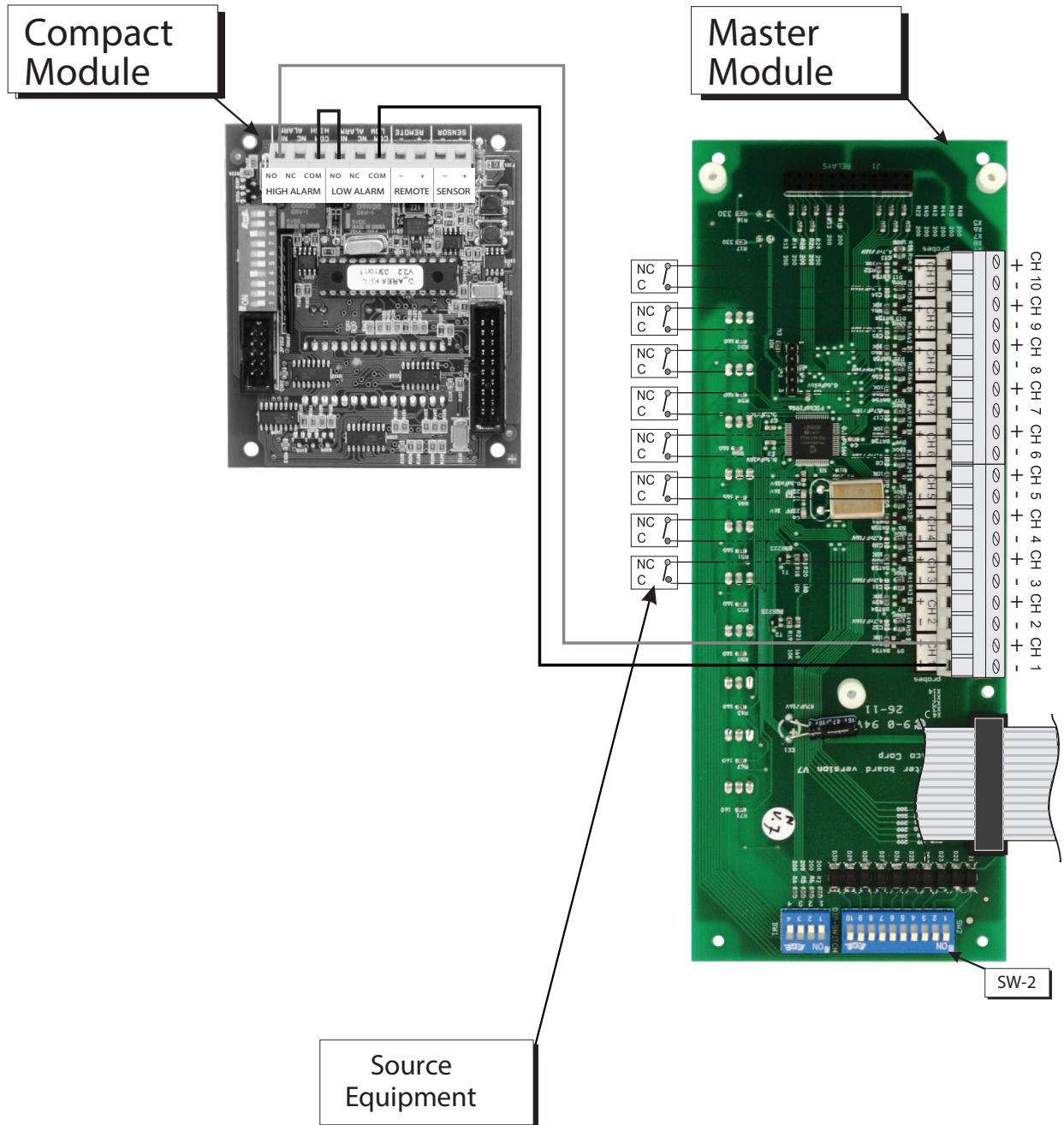

NOTE: Jumper any unused points on the Master module.

Turn OFF dip-switches for any unused points (Location SW-2).

Appendix H

WIRING DIAGRAM: MASTER/NEMA 4 MODULE

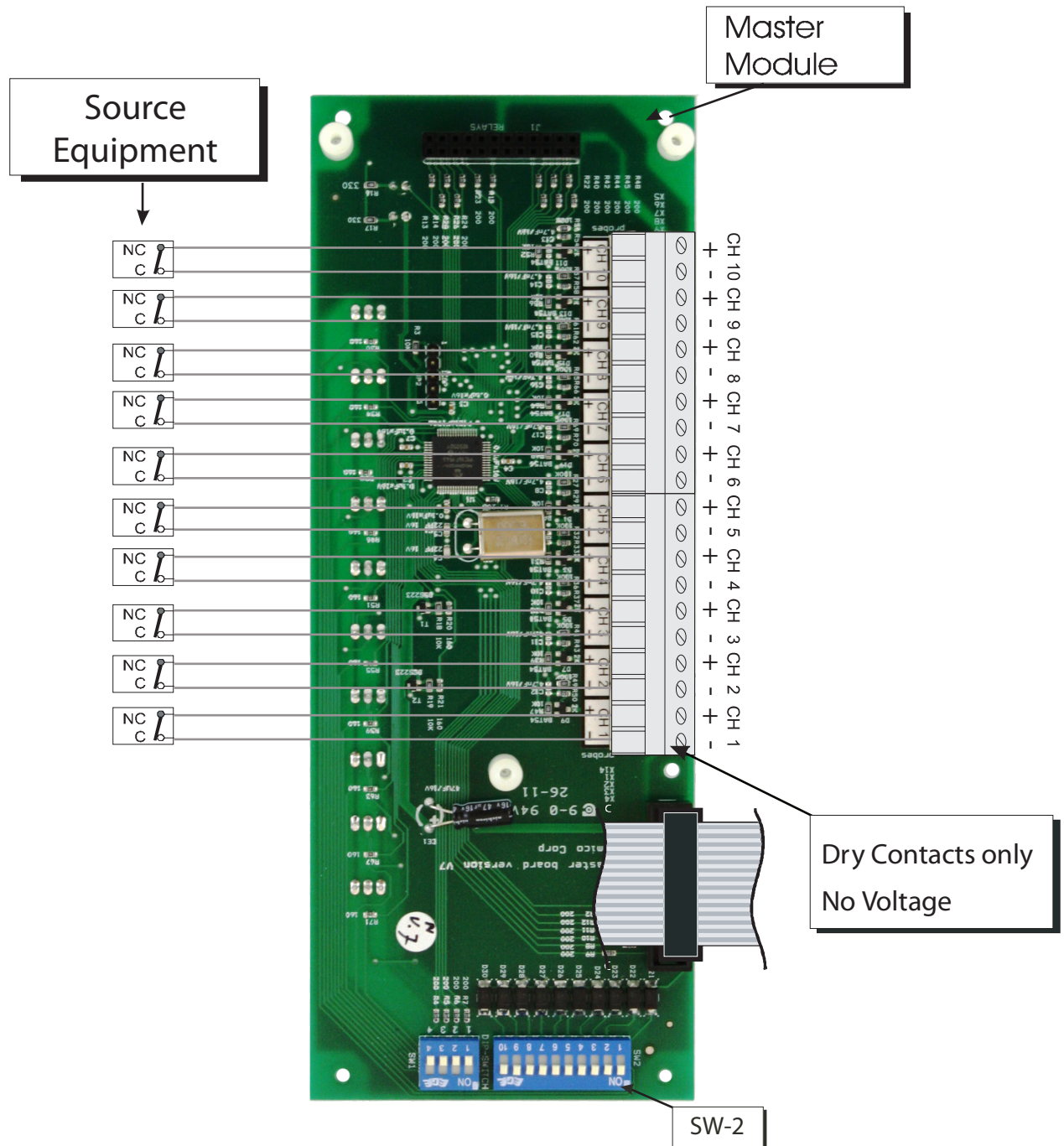

NOTE: Jumper any unused points on the Master module.

Turn OFF dip-switches for any unused points (Location SW-2).



CAUTION: Source equipment signal wires must be connected to normally-closed dry contacts. No electrical voltage can be present and contacts must be closed during normal equipment operation. When contacts are open; an alarm condition will be activated.

Appendix I

WIRING DIAGRAM: PRESSURE SWITCH CONNECTION TO A MASTER ALARM

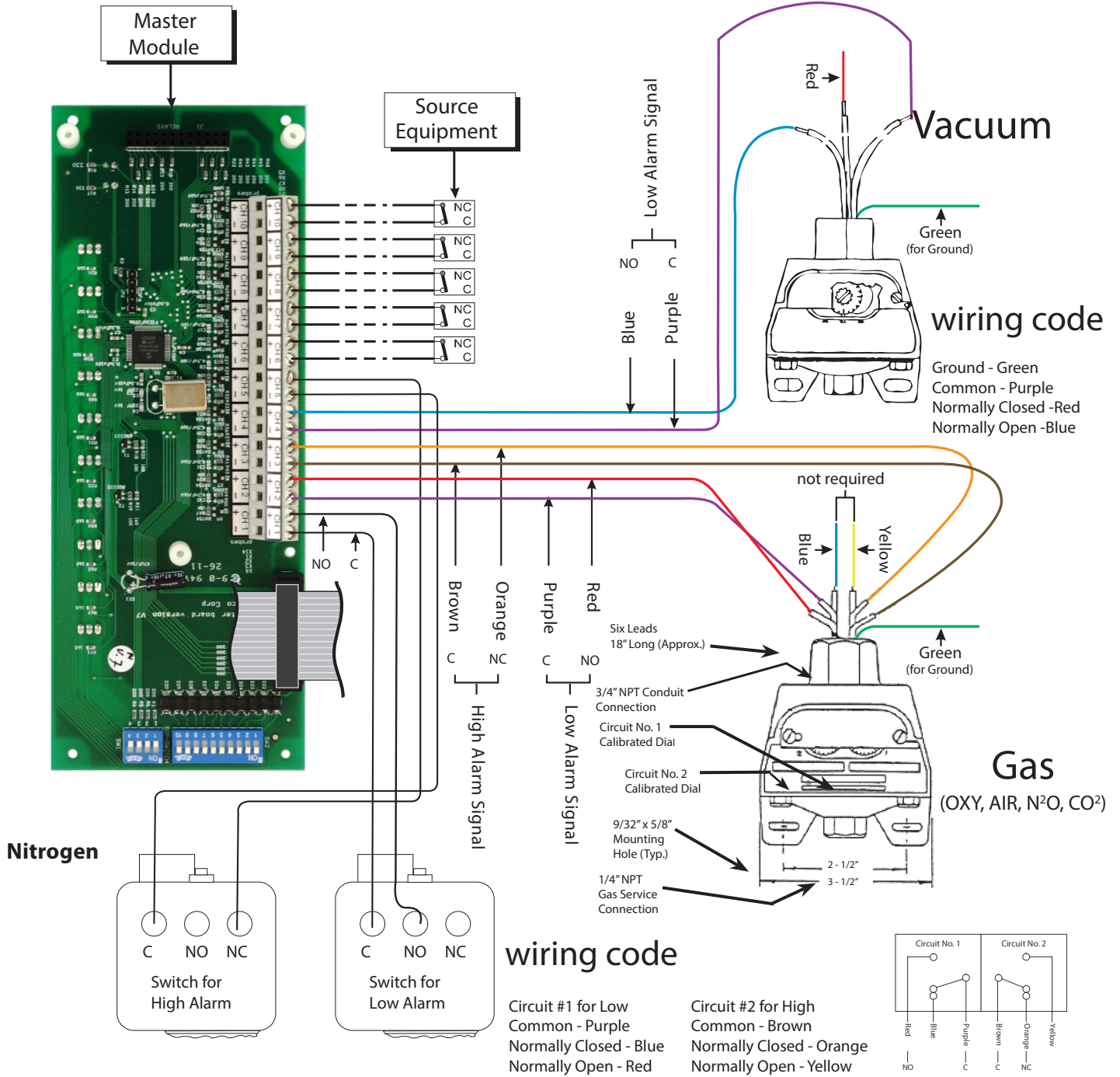

NOTE: There are 2 NIT switches, one for high alarm and one for low alarm.

Appendix J

WIRING DIAGRAM: COMPUTER INTERFACE MODULE

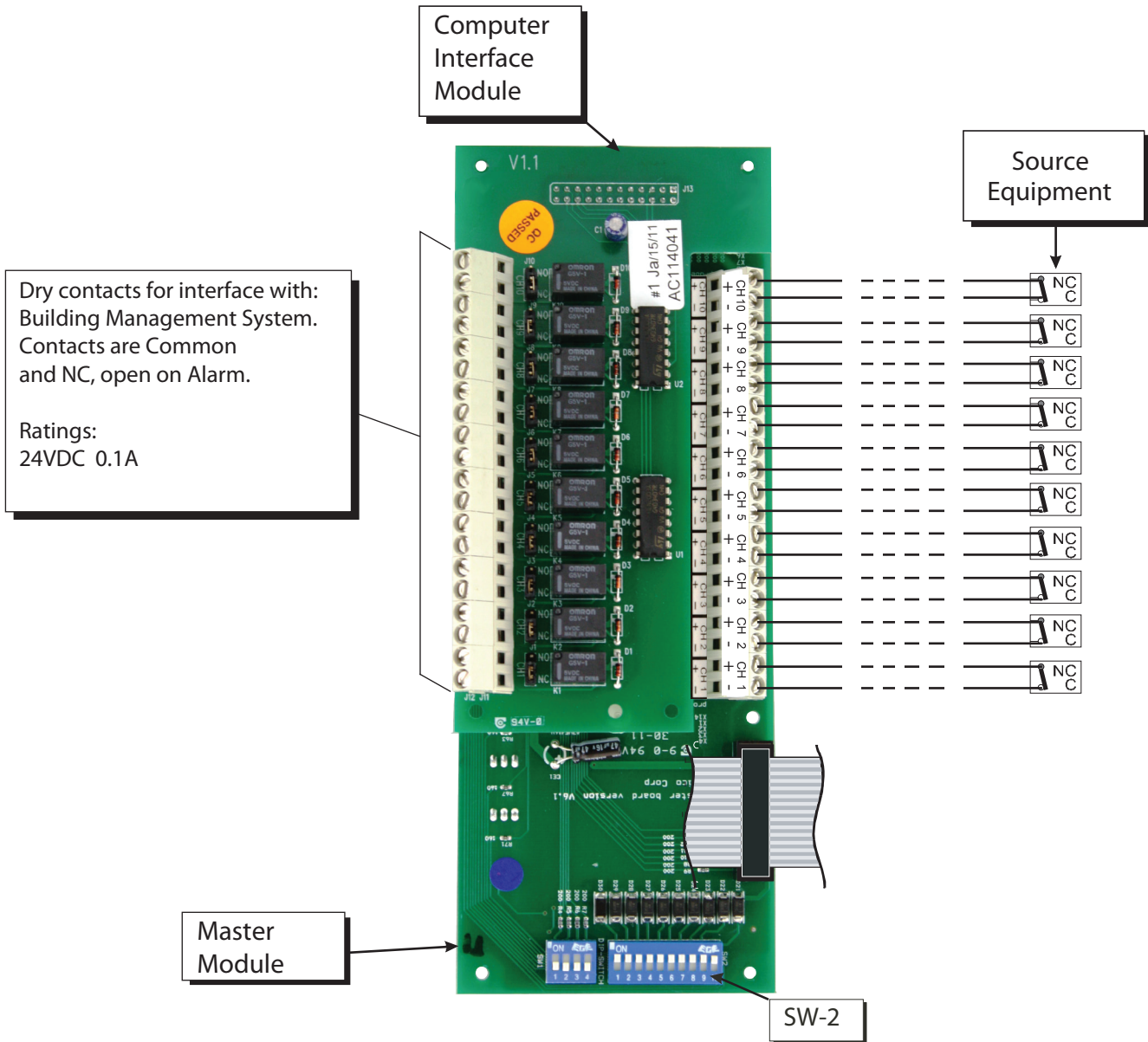

NOTE: Jumper any unused points on the Master module.

Turn OFF dip-switches for any unused points (Location SW-2).

Appendix K

Wiring Diagram Master to Slave Module

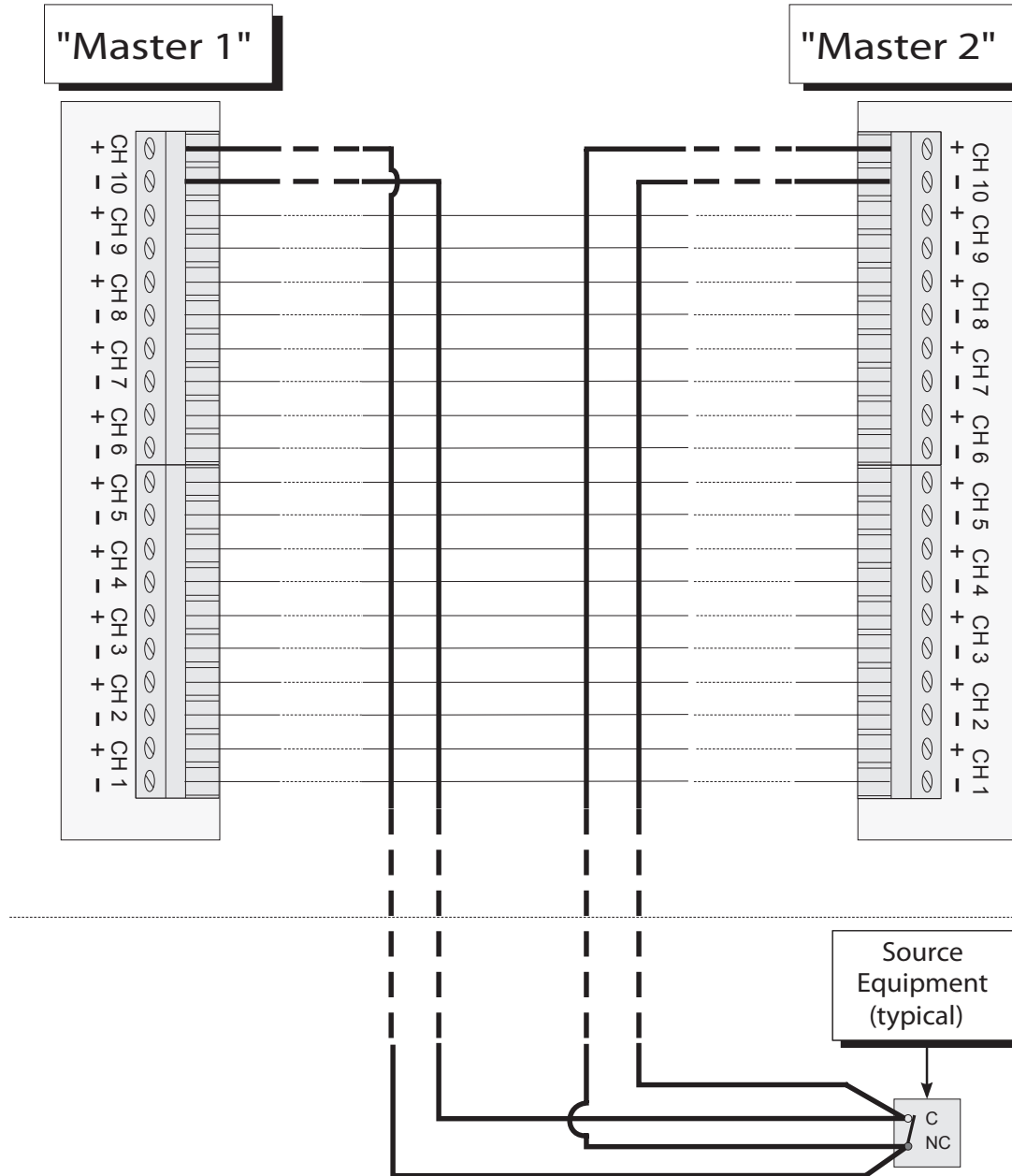

NOTE: Jumper any unused points on the Master module. Turn OFF dip-switches for any unused points (Location SW-2).

Each pair of terminals on the signal board connector is labeled "+" and "-". Ensure that when a source equipment dry contact is wired to two master panels, the same side of the dry contact is wired to two master panels. For example, if the source equipment is normally closed, contact is wired to the "+" of the first master panel. Ensure it is also connected to the "+" terminal of the second master panel.

Appendix L

Technical Specifications

Supply Voltage: 115 to 220 VAC - 50 to 60 Hz
Current Draw: 1 Amp Max
Fuse (1/4 * 1-1/4): Fast Blow 1 Amp

Cable requirement:

Area Display Module to Remote Sensor

Distance: Maximum 2,500 feet [750 m]

Cable: Only a #22 gauge stranded, shielded twisted pair cable must be used. (Belden # 8451 or equivalent). In the presence of any electrical, magnetic, radio frequencies, wireless or other interference, cable installation MUST be placed in metallic conduit.

Signal: 30 VDC - 1.0 Amps
60 VDC - 0.3 Amps
125 VAC - 0.5 Amps

Master Module to Source equipment:

Distance: Maximum 10,000 feet [3,000 m]

Cable: Minimum #22 gauge stranded wire (does not have to be shielded, twisted pair)

Signal: 5 VDC, < 5 μ A

Computer Interface Board:

Output: Dry Contacts NC, open on Alarm

Rating: 30 VDC - 1.0 Amps
60 VDC - 0.3 Amps
125 VAC - 0.5 Amps



CAUTION: Source equipment signal wires must be connected to normally-closed dry contacts. No electrical voltage can be present and contacts must be closed during normal equipment operation. When contacts are open; an alarm condition will be activated.

Appendix M

Wiring

1. General Requirements

1. All wiring shall be protected from physical damage by raceways, cable trays or conduit in accordance with NFPA 70, National Electric Code or the Canadian Electrical Code.
2. All alarms are to be powered from the life safety branch of the emergency power system as required by applicable standards.
3. Alarm panel wires should be directly connected to switches or sensor as required by applicable standards.
4. All wire runs should be made with color coded wire. Record color, signal and source of signal for each wire lead to aid in connection of alarm finish components.
5. The alarm panel and remote sensors should not be installed near radio transmitters, electrical motors, electrical control room, switchgear, CT scanners, MRI machines or high voltage lines.
6. In the presence of any electrical, magnetic, radio frequencies, wireless or other interference, cable installation **MUST** be placed in metallic conduits.
7. No solid wire should be used for connecting sensors or master alarms to source equipment.
8. To protect from static electricity, ensure to discharge body static before installing the Medical Gas Alarm and Sensors.
9. Do not ground the shield drain wire at sensor or inside alarm panel back box.
10. Electrical cable should not run below sensors or behind the alarm box, to protect from radio frequencies and EMI.

2. Low Voltage wire type, size and other requirements

All low voltage wiring must meet the following criteria:

1. #22 AWG stranded, shielded twisted pair wire **ONLY** must be used, rated for 300V and 60°C (140°F) minimum. (Belden 8451 or equivalent).
2. Marrette the sensor cable in a junction box (supplied by others) to the installation cable (supplied by others) to protect from physical damage, radio frequencies and EMI.
3. For multiple sensors, a multi-conductor #22 gauge stranded, shielded and twisted pair cable **ONLY** must be used.

The following rules along with references to this manual's schematics clarify wiring requirements. Two conductor cables (must be #22 gauge stranded, shielded and twisted pair cable type) are required for each Gas Sensor module to the Gas Input board.

Notes

BROWARD **A&C**
MEDICAL GAS SPECIALISTS

954-725-1470 Ext. 403

