

## TotalAlert Infinity™ Medical Gas Notification System

### SPECIFICATION

#### Medical Signaling Device

The TotalAlert Infinity™ medical gas notification system provides master and area alarm signals as required by the latest edition of NFPA 99. The alarm is ETL listed to UL 1069 and CSA C22.2 No.205 Signal Equipment.

All field wiring and signals are self-monitoring and on a closed circuit. Fault signals activate on an open circuit.

#### The Right Instruction

- The TotalAlert Infinity™ alarm panels allow users to set up customized instructions for each alarm signal, to appear on the screen when the signal is in alarm.
- Create custom instructions with the touch screen interface on the alarm panel LCD.
- Incorporate user-defined instructions into an emergency response plan by the facility.

#### 10.2" Touch Screen LCD Display

- TotalAlert Infinity™ Master, Area, and Combination Alarms have a 10.2" touch screen LCD display.
- The LCD touch screen display allows for all alarm programming and set up on site without the use of tools.
- A Green NORMAL condition on the home screen shows that there are no alarms active.
- The home page includes a location/area served badge for the alarm panel, customizable with the keyboard feature of the touch screen during the set up process.
- LCD display contains an adjustable background with many color/brightness options.
- LCD display backlight includes a "sleep mode" option via motion sensor to preserve screen life, adjustable from 5 minutes to 60 minutes. By default, the alarm sleep mode option is not active and the backlight remains on all of the time. If option is active and an alarm occurs during "sleep mode", the backlight turns on and remains on during the alarm condition.
- A full diagnostic self-test of the alarm tests the alarm signals (green and red), the LED indicators on the front panel, the audible horn, and displays all of the alarm set points. Initiate test with the touchscreen controls.

#### Ethernet Connectivity with Embedded Web Page

- A built-in web server in each panel allows a remote operator to display the alarm's web page and view alarm signals, pressures, and other networked devices.
- Ethernet communication is compatible with BeaconMedaes TotalAlert Embedded source equipment, TotalAlert Embedded manifolds, and TotalAlert alarm panels.
- The panel's web page contains links to all other TotalAlert devices on the network, including other alarm panels and source equipment.
- Electronic notification is available through e-mail/text messaging
  - » Accessible through any SMTP gateway
  - » Allows for remote alerts of alarm conditions

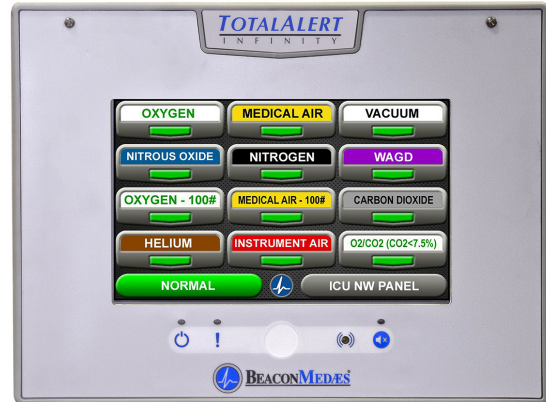

Master Alarm Panel (Up to 60 locally wired signal inputs, with ability to pull signals from 8 other TotalAlert Infinity™ alarms through Ethernet for maximum of 320 monitored signals).



Combination Alarm (Up to 60 locally wired signal inputs and 6 gas services)

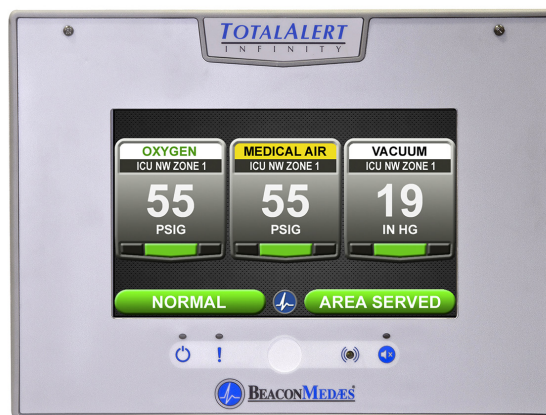

Area Alarm Panel (Up to 8 gases)

### History Log

- Event log accessible on LCD display records all alarms and panel activity, displays most recent 100 events.
- Event log is downloadable through embedded web page, including most recent 1000 events.

### Mirroring

- Capture and display (mirror) digital readings (pressure/vacuum levels) and source signals from other TotalAlert Infinity™ alarm panels via Ethernet.
- Customize alarm instructions on mirrored pressures and signals, enabling unique instructions at each panel.

### 4-20mA Option

- Set up any 2 or 3 wire 4-20mA transducer with user-defined values.
- Customize badges through the touchscreen interface to display the 4-20mA readings, including color, identification, location, value settings, and alarm set points (high and low).
- Each 4-20mA monitored condition shows a separate green display when NORMAL and a red display when in ALARM.

### BACnet

- Utilize the built-in Ethernet connection for BACNET transmission of signals to a Building Automation System.
- TotalAlert Infinity™ alarms employ the TCP/IP family of protocols for communication and each device has a unique IP address.
- Each TotalAlert Infinity™ alarm panel conforms to the BACnet protocol and includes a Protocol Implementation Conformance Statement (PICS).

### Wireless

- WiFi 802.11 b/g/n interface provides access with any web enabled device to panel web page and retrieve operating information and event history.

### Power

- Input power to the alarm panel is 100 to 250 VAC 50/60 Hz, fused on the input side rated at 250mA, time-delayed.
- The internal power supply converts the input voltage to low voltage 24 VDC.
- All user accessible electronics and wiring utilize low voltage.
- Plastic guard protects user from high voltage wiring.

### Transport & Storage

During transport and storage, do not exceed an ambient temperature range of 0°F to 130°F (-18°C to 55°C), a relative humidity range of 10% to 85% with non-condensation, and an atmospheric pressure range of 950 hPa (millibar) to 1050 hPa (millibar).

### Front Panel Indicators

- Green POWER ON LED indicator illuminates when the alarm panel is powered.
- WARNING LED alerts the user to unused signals and communication issues which are not alarm causing conditions.
- Audible HORN produces a minimum sound pressure level of 80 dBA measured at a distance of 3 ft. (.92m), adjustable to 90 dBA at 3 ft. (.92m).
- MUTE button indicator LED flashes red during an alarm condition and remains illuminated as a constant red after silencing until the fault is corrected.

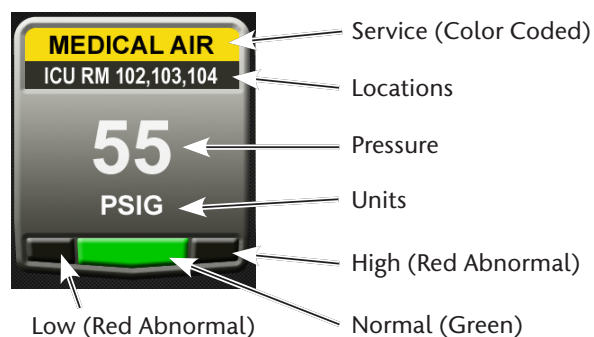
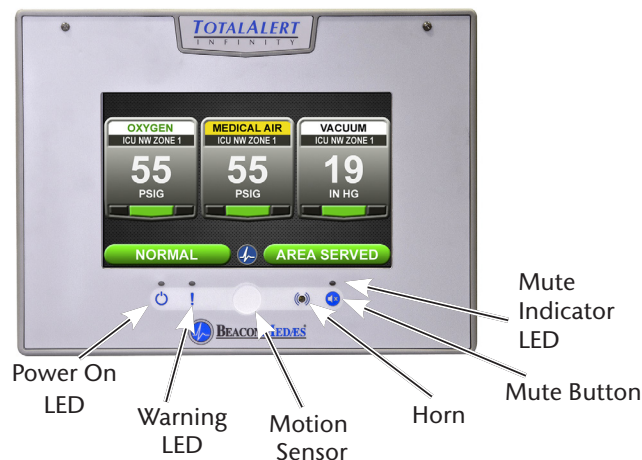

Area Gas Badge

### Area Alarm Digital Sensor

- Gas specific digital gas sensor contains a transducer capable of providing factory calibrated signals to the alarm panel.
- Gas sensors may be located inside the alarm rough-in (local) or outside the alarm rough-in (remote).
- When installed remotely, sensors may be located up to 1524 m (5,000 feet) from the alarm panel.
- Pipeline connections are 3/8" nominal (1/2" OD) type K copper tube and include a DISS check fitting.
- Digital gas sensors include a "heartbeat" flashing green LED light to designate that sensor is functioning correctly.

### Area Alarm Panel Configuration

- Area alarm panel monitors 1 to 8 digital gas sensor modules, installed locally or remotely.
- Display screen continuously displays the monitored gas pressures or vacuum in the piping system.
- Customize gas badges on the display for gas types, color, and language. Type in areas served per gas during set up process through the touchscreen interface.
- Program the units of measure for each gas badge to read PSI, BAR, and kPa in increments of 1 PSI, .1 BAR, and to 10 kPa respectively.
- Visual indicators for system pressure or vacuum are NORMAL (green) and individual indicators (red) for alarm fault condition such as LOW or HIGH pressure.
- Low and high alarm points are factory set per NFPA 99 standards, but remain field programmable through touch screen interface.
- The Area alarm panel contains a general fault relay for the entire panel or add an optional relay board to provide the pressure fault status for each gas.

### Master Alarm

- Master alarm panel monitors up to 60 normally closed dry contact switch signals wired locally.
- Monitor additional source signals from up to 8 remote TotalAlert Infinity™ alarm panels via Ethernet and display up to 320 master signals.
- Display up to 320 master signals transmitted from other TotalAlert Infinity™ alarm panels via Ethernet or through Building Automation Systems via BACNet (mirroring).
- Consolidated view provides an easy to read overview of all source equipment status, with 12 gas-type badges to group signals.
- Status for each signal, shown on the touchscreen, is Green under normal conditions (closed) and flashing Red under fault conditions (open).
- During a fault condition, the visual green NORMAL display turns off, the location icon flashes red, the active alarm icon flashes red, and the audible alarm sounds.
- Optional relay boards provide up to 48 dry contacts normally closed relays for connection to a building automation system. Relay ratings are 30 VAC/VDC 3A max.
- Master alarms allow for optional relay outputs tied to single or multiple alarm conditions.

### Combination Alarm

- Alarm panels monitor a combination of normally closed dry contact switch signals, digital gas sensor modules, and 4-20mA transducers.
- Alarm panel is capable of monitoring up to 60 normally closed dry contact switch signals wired locally and up to 6 digital gas sensors.

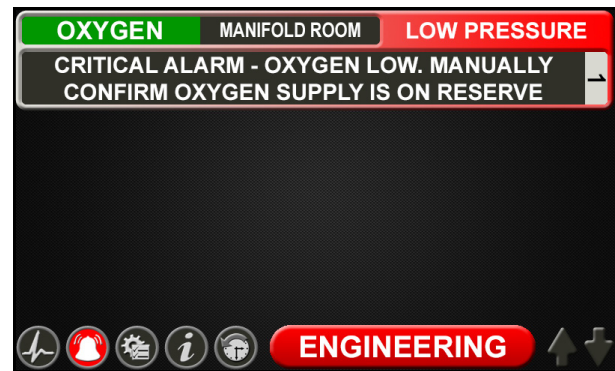

Source alarm signal with custom, alarm specific instruction

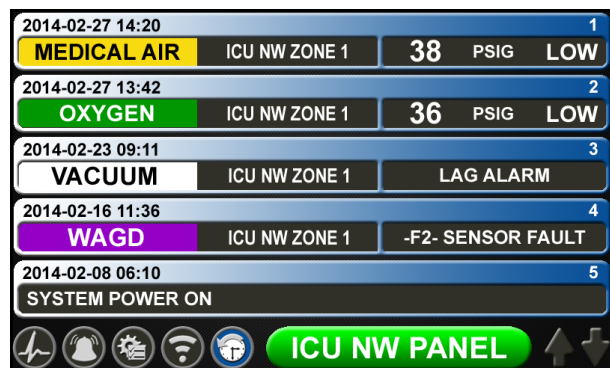

Alarm history, stores 100 events at the panel, with 1000 events downloadable from web page

TOTALALERT INFINITY									
Alarm Signals									
Data at 2015-04-21 10:41:48 [Refresh] (Auto refresh every 5 seconds)									
<<< All conditions are NORMAL >>>									
Source Alarm Signals									
Gas Type	Message	Location	Alarm Point	Status	Silenced				
MEDICAL AIR	GENERAL FAULT	SOURCE ROOM	WR B65 303	NORMAL	N/A				
MEDICAL AIR	GENERAL ALARM	SOURCE ROOM	WR B65 304	NORMAL	N/A				
MEDICAL AIR	LAG ALARM	SOURCE ROOM	WR B65 305	NORMAL	N/A				
MEDICAL AIR	HIGH DRIPPOINT	SOURCE ROOM	WR B65 306	NORMAL	N/A				
MEDICAL AIR	HIGH CO LEVEL	SOURCE ROOM	WR B65 307	NORMAL	N/A				
Area Alarm Signals									
Gas Type	Reading	Low	High	Location	Alarm Point	Status	Silenced		
OXYGEN	55 PSIG	40	60	MANIFOLD ROOM	WR B65 001	NORMAL	N/A		
WAGD	19 IN HG	12	NONE	BASEMENT D	WR B65 002	NORMAL	N/A		

Embedded Web Page, allows for full management of medical gas system through any web enabled device on the network

**TotalAlert Infinity™ Alarm Models**

**T3** -      -       
           **B**      **C**

**NOTE:** For Area Alarm panels, sensor assemblies are not specific to "Remote" or "Local" installations. It is not necessary to designate the installation type in the model numbering.

Variable B Alarm Type and Size	
Allowable Value	Description
B00	Blank
A10	Area Alarm, Up to 8 Area Gases
M01	Master, 0 Inputs, 16 Relay Outputs
M10	Master, 20 Inputs
M11	Master, 20 Inputs, 16 Relay Outputs
M12	Master, 20 Inputs, 32 Relay Outputs
M13	Master, 20 Inputs, 48 Relay Outputs
M20	Master, 40 Inputs
M21	Master, 40 Inputs, 16 Relay Outputs
M22	Master, 40 Inputs, 32 Relay Outputs
M30	Master, 60 Inputs, 0 Relay Outputs
M31	Master, 60 Inputs, 16 Relay Outputs
C01	Combination, 10 Inputs, 6 Relay Outputs, Up to 3 Area Gases
C10	Combination, 20 Inputs, Display up to 6 Area Gases
C11	Combination, 20 Inputs, 16 Relay Outputs, Display up to 6 Area Gases
C12	Combination, 20 Inputs, 32 Relay Outputs, Display up to 6 Area Gases
C20	Combination, 40 Inputs, Display up to 6 Area Gases
C21	Combination, 40 Inputs, 16 Relay Outputs, Display up to 6 Area Gases
C30	Combination, 60 Inputs, Display up to 6 Area Gases
C40	Combination, 7 Inputs, 6 Relay Outputs, 4 Inputs for 4-20mA devices
C41	Combination, 27 Inputs, 6 Relay Outputs, 4 Inputs for 4-20mA devices
C42	Combination, 47 Inputs, 6 Relay Outputs, 4 Inputs for 4-20mA devices
C43	Combination, 67 Inputs, 6 Relay Outputs, 4 Inputs for 4-20mA devices
C44	Combination, 7 Inputs, 6 Relay Outputs, 4 Inputs for 4-20mA devices, Up to 6 Area Gases (maximum display of 6 gas badges, in combination of 4-20mA and gas sensors)

Variable C Gas Type (Area and Combination Only)	
Allowable Value	Description
O	Oxygen
X	Nitrous Oxide
A	Medical Air
V	Medical Vacuum
W	WAGD
N	Nitrogen
C	Carbon Dioxide (CO2)
D	Oxygen 100 psig
F	Medical Air 100 psig
G	Carbon Dioxide 100 psig
9	Instrument Air
1	CO2-O2 (CO2 over 7%)
2	O2-CO2 (CO2 not over 7%)
3	HE-O2 (HE over 80%)
4	O2-HE (HE not over 80%)
7	Laboratory Air
8	Laboratory Vacuum
H	Helium
J	Argon
S	Surgical Air
B	AGSS
E	N2O-O2
M	Mixed Gas

**Example:** TotalAlert Infinity™ Master Alarm with 40 Inputs and 32 Relay Outputs

**Example Model Number:** T3-M22

**Example:** TotalAlert Infinity™ AREA Alarm with 4 gases - Oxygen, Nitrous Oxide, Medical Air, and Vacuum

**Example Model Number:** T3-A10-OXAV

**Example:** Combination Alarm with 10 Inputs, 6 Relay Outputs, and 3 gases - Oxygen, Medical Air, and Medical Vacuum

**Example Model Number:** T3-C01-OAV

**Example:** Combination Alarm with 7 Inputs, 6 Relay Outputs, 4 4-20mA devices, and 2 gases - Oxygen, Medical Air

**Example Model Number:** T3-C44-OA

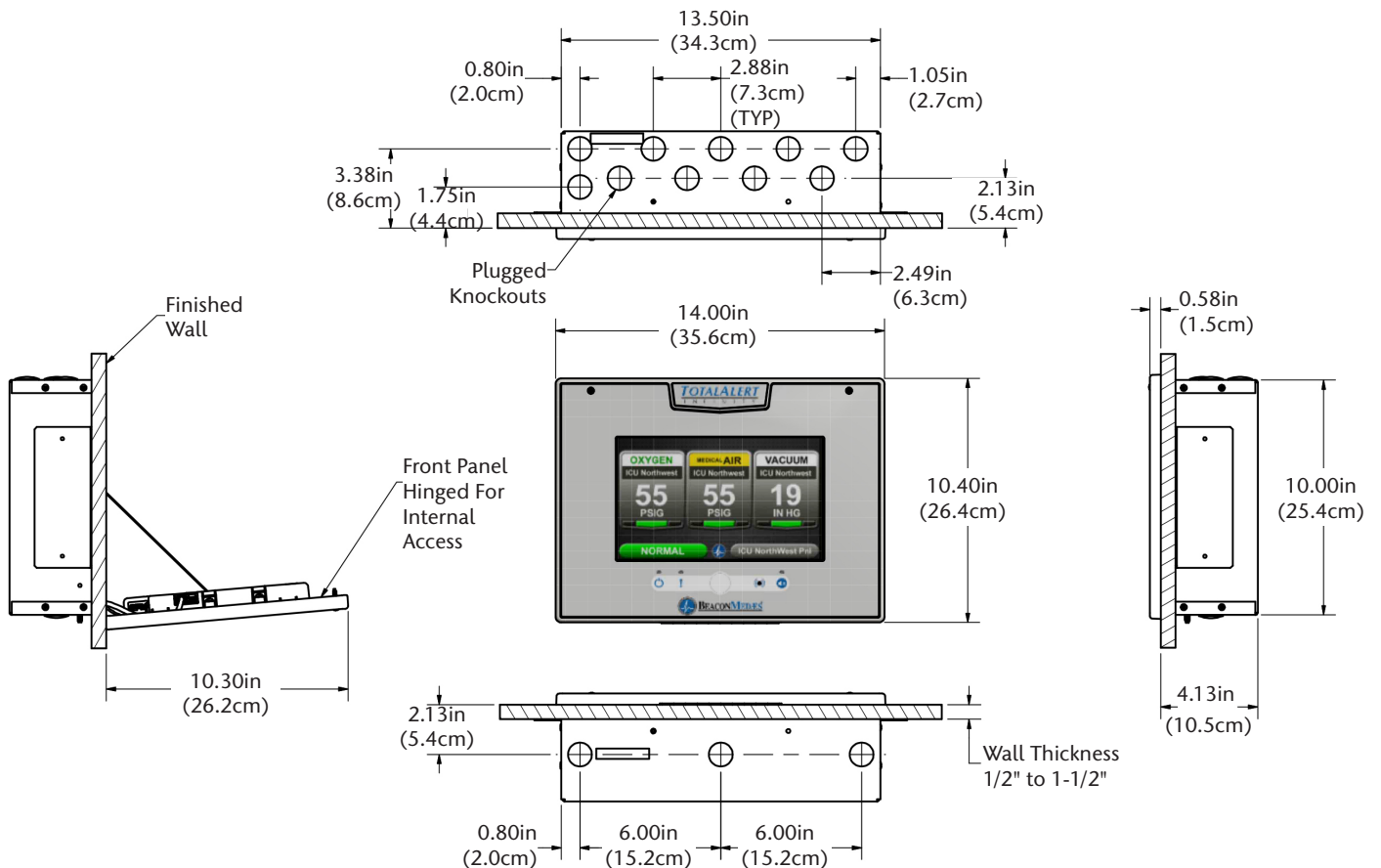
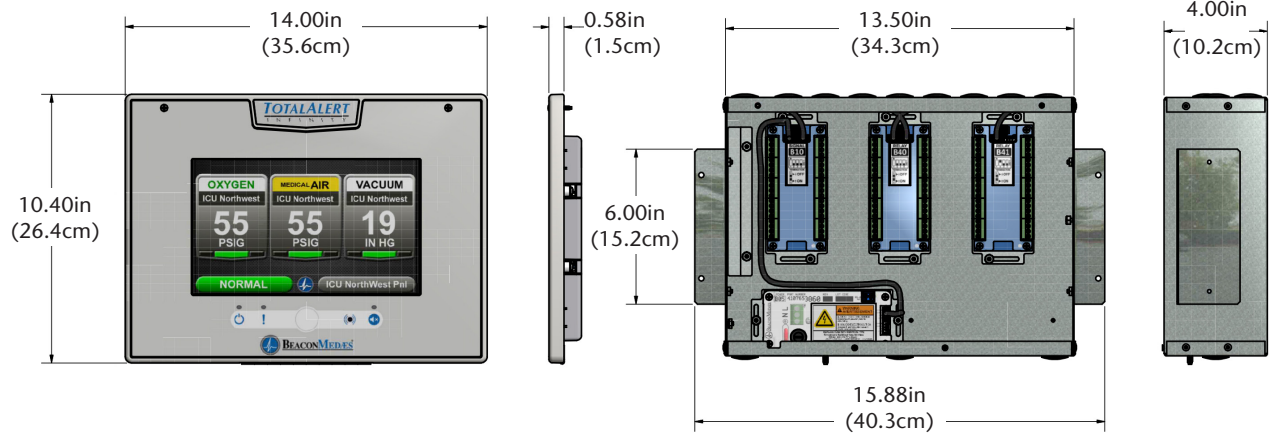
**TotalAlert Infinity™ Alarm Dimensions**

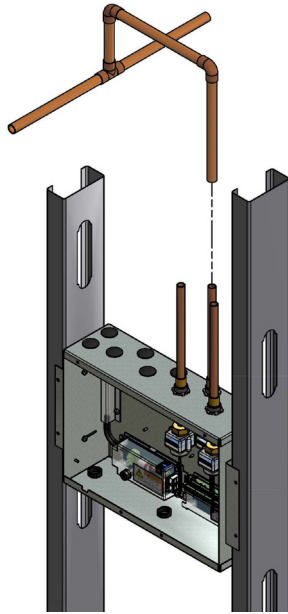
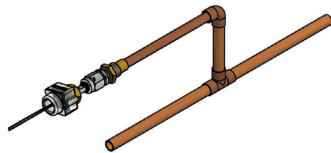
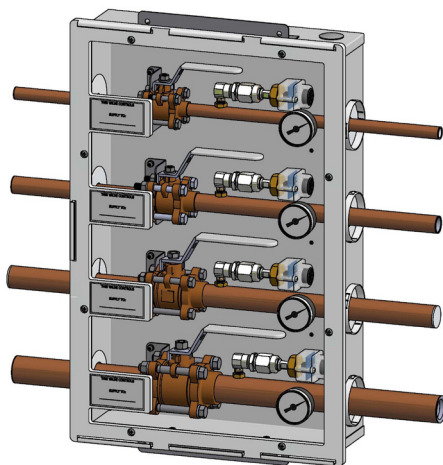
**Total Alert Infinity™ Area Alarm Gas Sensor Installation**

*Local Sensor Installation*

*Remote Sensor Installation*

*Zone Valve Box Sensor Installation*

(For Zone Valve Box mounting, an additional Installation Kit is required, part number 4107 4016 25 for each sensor)

**TotalAlert Infinity™ Alarm: Additional Components**

Gas Sensor Module Options	
Part Number	Gas Type Sensor Assembly
4107 4016 75	Oxygen
4107 4016 76	Nitrous Oxide
4107 4016 77	Medical Air
4107 4016 78	Medical Vacuum
4107 4016 79	Nitrogen
4107 4016 80	Instrument Air
4107 4016 81	WAGD
4107 4016 82	Carbon Dioxide
4107 4016 83	Carbon Dioxide/Oxygen
4107 4016 84	Oxygen/Carbon Dioxide
4107 4016 85	Helium/Oxygen
4107 4016 86	Oxygen/Helium
4107 4016 87	Helium
4107 4016 88	Laboratory Air
4107 4016 89	Laboratory Vacuum
4107 4016 90	Oxygen 100 psig
4107 4016 91	Medical Air 100 psig
4107 4016 92	Carbon Dioxide 100 psig
4107 4016 93	Argon
4107 4016 94	AGSS
4107 4016 95	Nitrous Oxide/Oxygen

Gas Sensor Assembly includes the Gas Specific Sensor, DISS Check Fitting, and Copper Tube.

TotalAlert Infinity™ alarms are expandable with additional modules, see Operation & Maintenance Manual for options and part numbers.

